

# KB45H/80/150



## Short description

Channel elbow 80/150, 45°, horizontal

Article number

0055.0586

## Technical data

Material	Sheet steel, Sendzimir galvanised
Weight including packaging	0 kg
Channel dimension	150 mm x x 80 mm
Width with packaging	0 mm
Height with packaging	0 mm
Depth with packaging	0 mm
Packing unit	1 piece
Range	K
GTIN (EAN)	4012799555865

## Dimensioned drawing [mm]

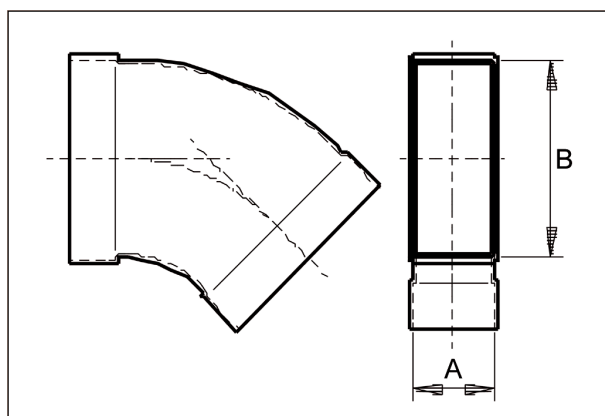

A	B
80	150