

KSD55/110/1200

Short description

Channel sound absorber 55/110, W = 150,

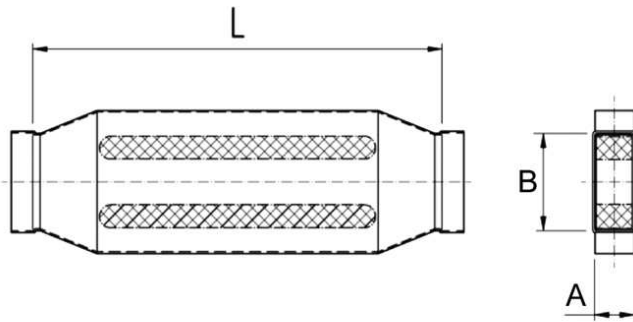

Article number 0092.0458

Technical data

Housing material	Sheet steel, Sendzimir galvanised
Channel dimension	110 mm x x 55 mm
Width	150 mm
Height	
Depth	
Packing unit	1 piece
Range	K
GTIN (EAN)	4012799924586

Dimensioned drawing [mm]

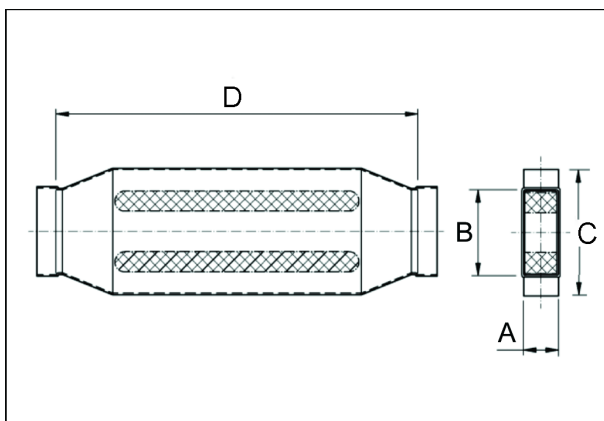

A	B	C	D
55	110	150	1.200