

KSD80/150/700

Short description

Channel sound absorber 80/150, W = 230,

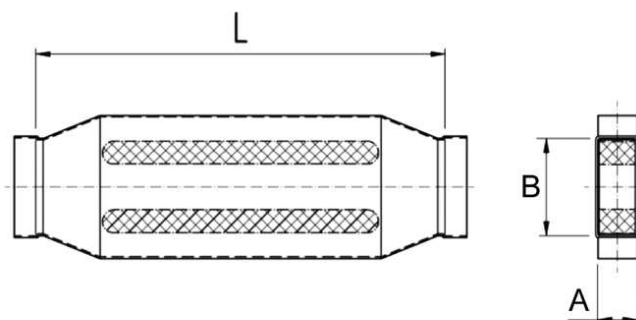

Article number 0092.0455

Technical data

Housing material	Sheet steel, Sendzimir galvanised
Channel dimension	150 mm x x 80 mm
Width	230 mm
Height	
Depth	
Packing unit	1 piece
Range	K
GTIN (EAN)	4012799924555

Dimensioned drawing [mm]

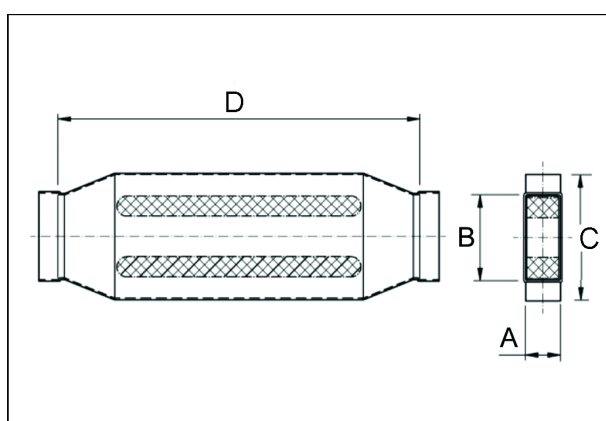

A	B	C	D
80	150	230	700