

KSD80/200/700

Short description

Channel sound absorber 80/200, W = 360,

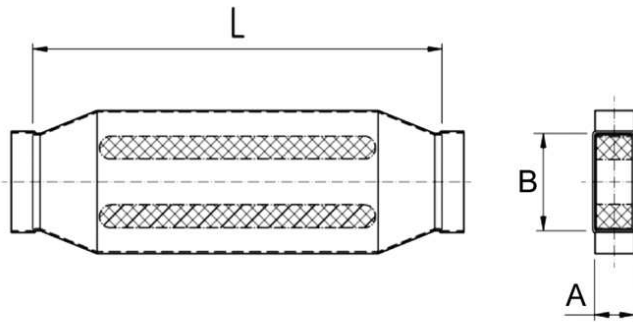

Article number 0092.0456

Technical data

Housing material	Sheet steel, Sendzimir galvanised
Channel dimension	200 mm x x 80 mm
Width	360 mm
Height	
Depth	
Packing unit	1 piece
Range	K
GTIN (EAN)	4012799924562

Dimensioned drawing [mm]

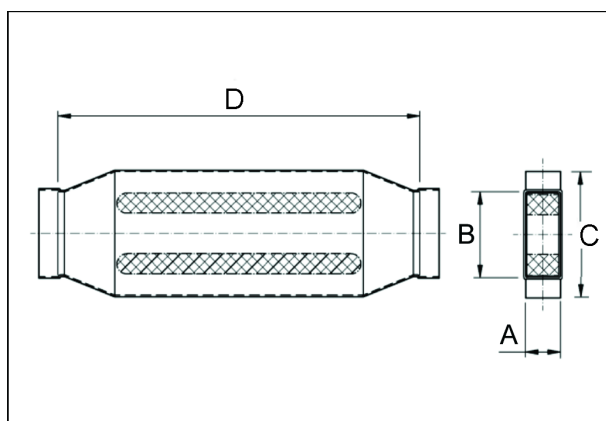

A	B	C	D
80	200	360	700