

KSDA55/220/1200



Short description

Channel sound absorber 55/220, W = 430,

Article number 0092.0471

Technical data

Housing material	Sheet steel, Sendzimir galvanised
Weight including packaging	0 kg
Channel dimension	220 mm x x 55 mm
Width	430 mm
Height	
Depth	
Width with packaging	0 mm
Height with packaging	0 mm
Depth with packaging	0 mm
Packing unit	1 piece
Range	K
GTIN (EAN)	4012799924715

Dimensioned drawing [mm]

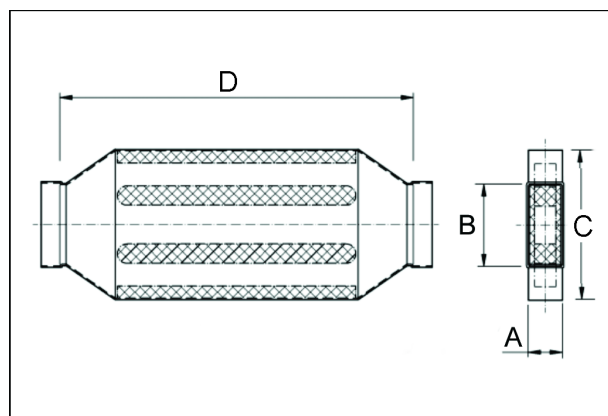

A	B	C	D
55	220	430	1.200