

KSDA70/170/1200



Short description

Channel sound absorber 70/170, W = 360,

Article number 0092.0469

Technical data

Housing material	Sheet steel, Sendzimir galvanised
Weight including packaging	0 kg
Channel dimension	170 mm x x 70 mm
Width	360 mm
Height	
Depth	
Width with packaging	0 mm
Height with packaging	0 mm
Depth with packaging	0 mm
Packing unit	1 piece
Range	K
GTIN (EAN)	4012799924692

Dimensioned drawing [mm]

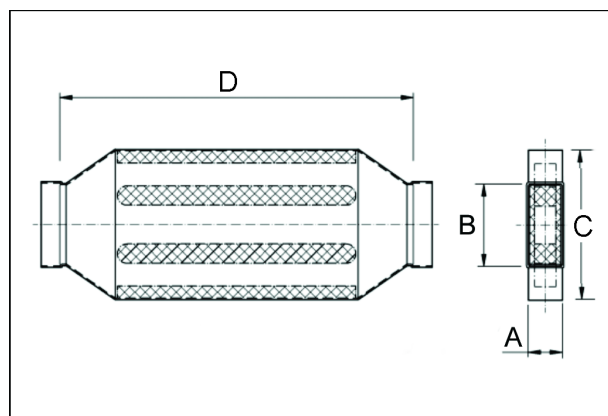

A	B	C	D
70	170	360	1.200