

LAP 50

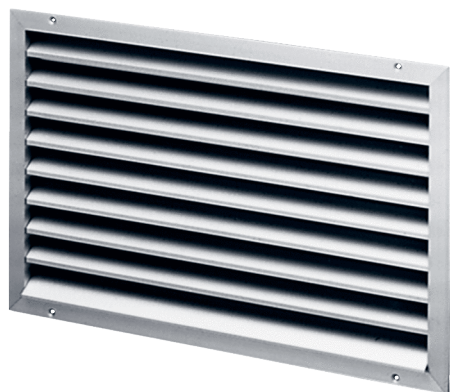

Short description

External grille, aluminium, channel dimension 800 x 500 mm

Article number 0151.0312

Technical data

Air direction	Ventilation and air extraction
Installation	outside
Installation site	Wall / Channel
Material	Aluminium
Colour	Anodised aluminium
Weight	8,6 kg
Weight including packaging	9,4 kg
Channel dimension	800 mm x 500 mm
Width	829 mm
Height	575 mm
Depth	73 mm
Width with packaging	890 mm
Height with packaging	620 mm
Depth with packaging	110 mm
Packing unit	1 piece
Range	D
GTIN (EAN)	4012799513124

LAP 50

Characteristic curve Pressure losses

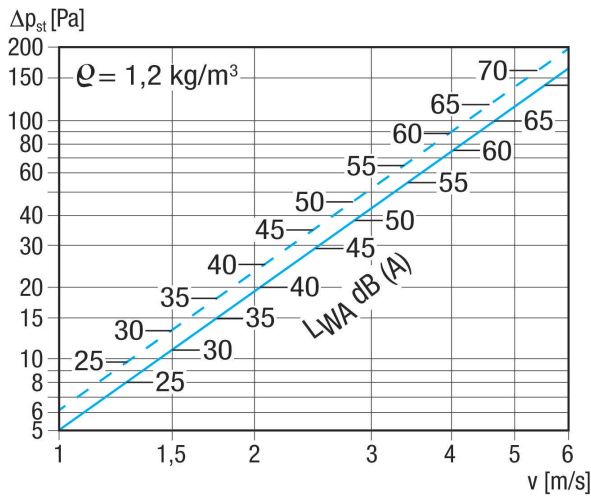

Dashed line: Pressure loss, drawing in
 Solid line: Pressure loss, pushing

Dimensioned drawing [mm]

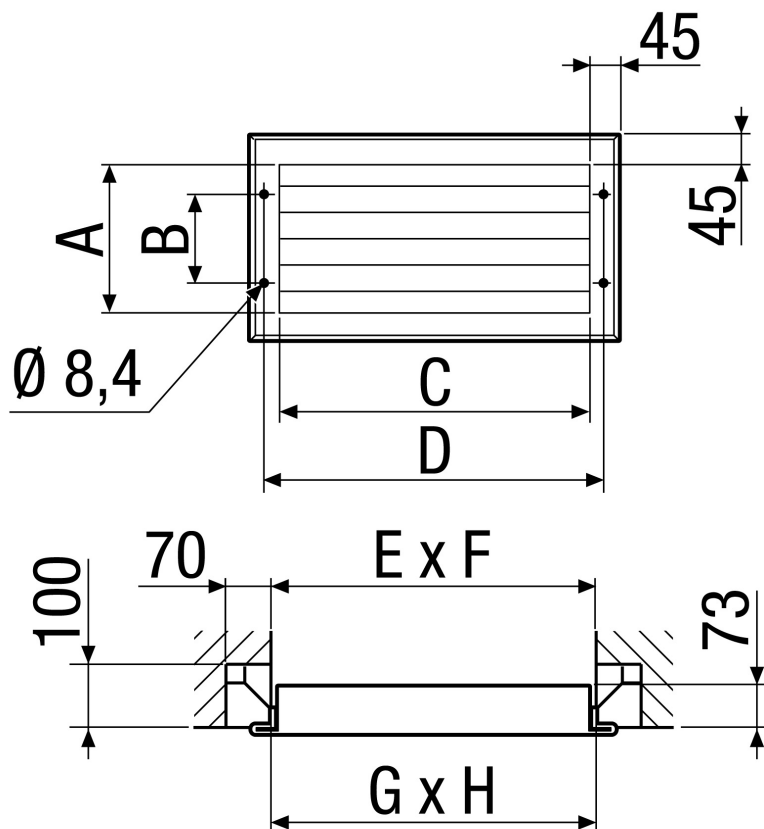

A	B	C	D	E	F	G	H
485	375	785	829	810	510	800	500

LAP 50

