

LGA 62/12

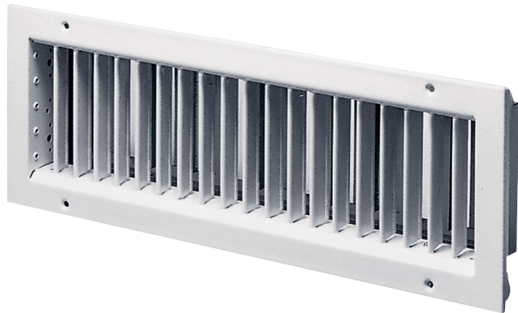

Short description

Exhaust air grille for combination with EK 62/12 installation box

Article number 0151.0261

Technical data

Air direction	Air extraction
Practical air throughput at 75% opening of the slot slide	200 m ³ /h - 500 m ³ /h
Installation	Inside
Installation site	Wall / Channel
Material	Sheet steel, stove-enamelled
Colour	light grey
Weight	2,35 kg
Weight including packaging	2,62 kg
Width	650 mm
Height	160 mm
Depth	61 mm
Width with packaging	670 mm
Height with packaging	175 mm
Depth with packaging	85 mm
Packing unit	1 piece
Range	D
GTIN (EAN)	4012799512615

LGA 62/12

Characteristic curve Static pressure difference and acoustic data

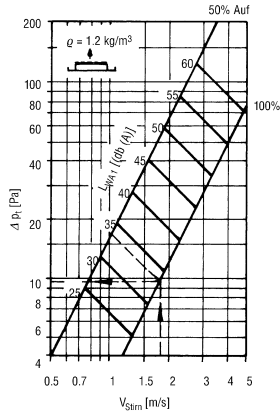

Stirnfläche (m²)

Höhe	Länge	625
125	0,041	0,061
225	-	0,112

- Δ Pt (Pa) = Druckverlust
- L_{WA1} [dB(A)] = bewerteter Schalleistungspegel bezogen auf A_{stirn} = 0,08 m²
- w_{stirn} (m/s) = Ansauggeschwindigkeit bezogen auf A_{stirn}
- kf [dB(A)] = Korrekturfaktor
- A_{stirn} (m²) = Stirnfläche
- L_{WA} = L_{WA1} + kf
- w_k (m/s) = Kanalgeschwindigkeit

Korrekturfaktor:

A _{stirn} (m ²)	.04	.06	.11
kf [dB(A)]	-3	0	+2

Characteristic curve Volumetric flow in countercurrent with frontal velocity

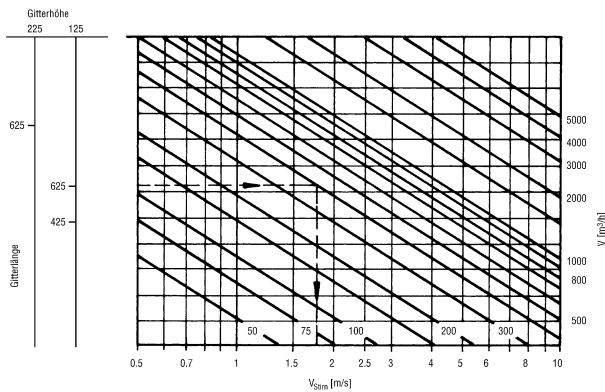

LGA 62/12

Dimensioned drawing [mm]

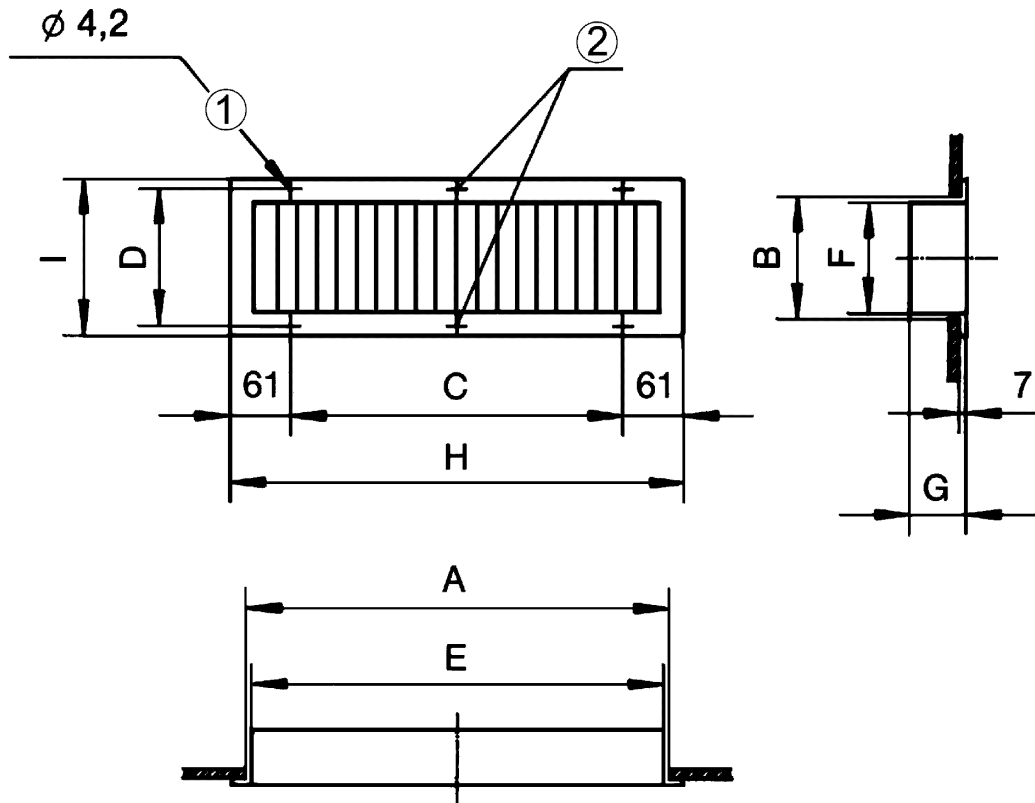

A	B	C	D	E	F	G	H	I
625	125	528	140	610	110	61	650	160

① For countersunk head screws

② Not available with LGA 42/12 and LGZ 42/12