

LZP 25



Short description

External grille, galvanised sheet steel, channel dimension 500 x 300 mm

Article number 0151.0256

Technical data

Air direction	Ventilation and air extraction
Installation	outside
Installation site	Wall / Channel
Material	Sheet steel, galvanised
Weight	7,15 kg
Weight including packaging	7,54 kg
Channel dimension	500 mm x 300 mm
Width	529 mm
Height	375 mm
Depth	73 mm
Width with packaging	590 mm
Height with packaging	380 mm
Depth with packaging	110 mm
Packing unit	1 piece
Range	D
GTIN (EAN)	4012799512561

LZP 25

Characteristic curve Pressure losses

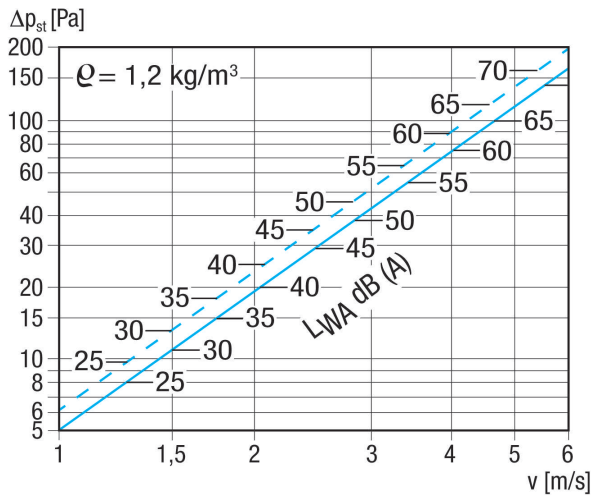

Dashed line: Pressure loss, drawing in
Solid line: Pressure loss, pushing

Dimensioned drawing [mm]

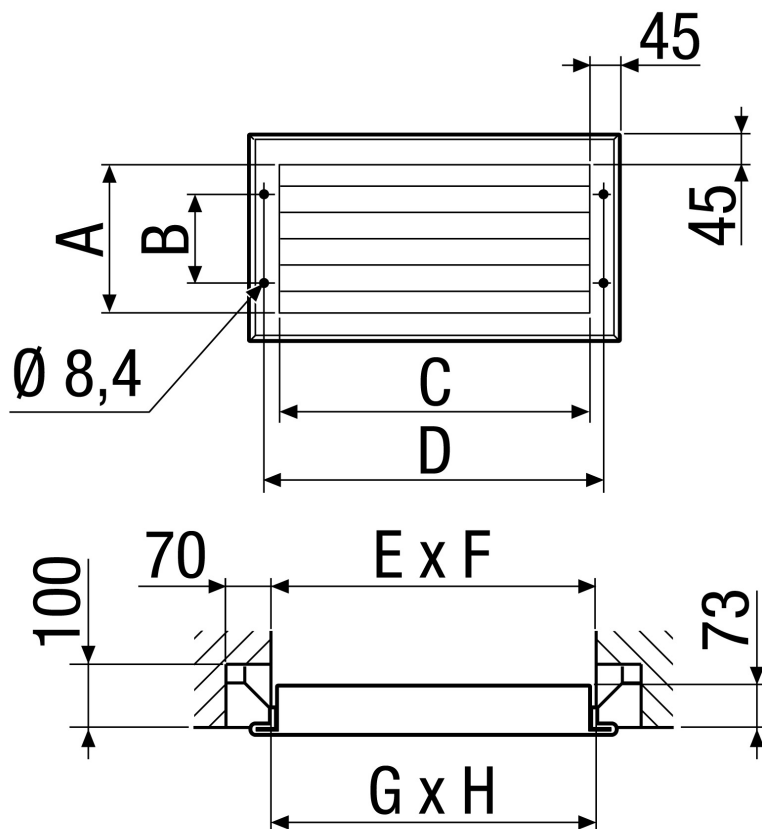

A	B	C	D	E	F	G	H
285	175	485	529	510	310	500	300

LZP 25

