

# LZP 28



## Short description

External grille, galvanised sheet steel, channel dimension 600 x 300 mm

Article number 0151.0257

## Technical data

Air direction	Ventilation and air extraction
Installation	outside
Installation site	Wall / Channel
Material	Sheet steel, galvanised
Weight	8,71 kg
Weight including packaging	9,19 kg
Channel dimension	600 mm x 300 mm
Width	629 mm
Height	375 mm
Depth	73 mm
Width with packaging	690 mm
Height with packaging	395 mm
Depth with packaging	105 mm
Packing unit	1 piece
Range	D
GTIN (EAN)	4012799512578

# LZP 28

## Characteristic curve Pressure losses

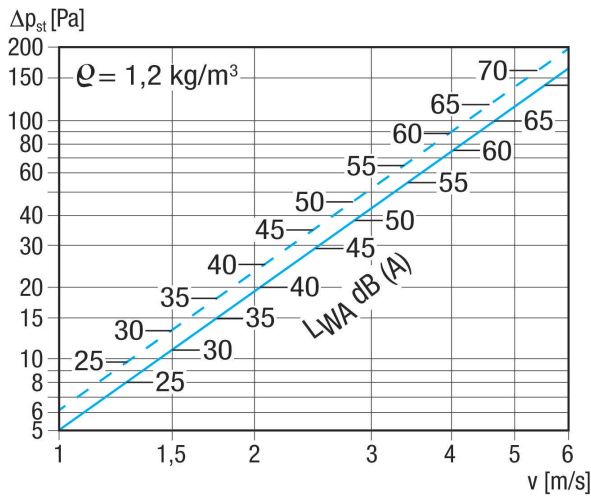

Dashed line: Pressure loss, drawing in  
Solid line: Pressure loss, pushing

## Dimensioned drawing [mm]

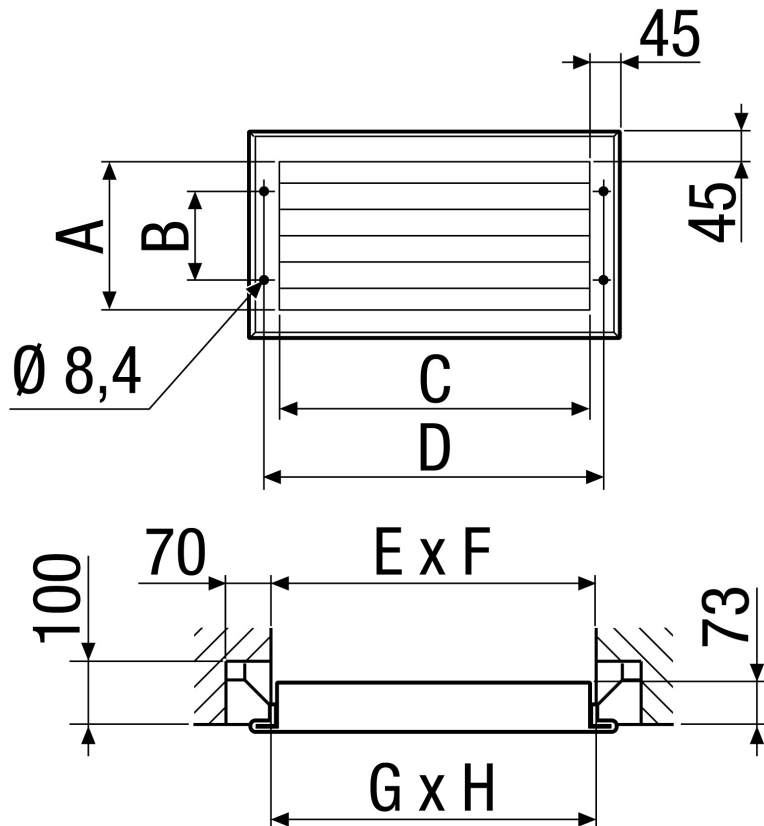

A	B	C	D	E	F	G	H
285	175	585	629	610	310	600	300

LZP 28

