

LZP 31



Short description

External grille, galvanised sheet steel, channel dimension 600 x 350 mm

Article number 0151.0258

Technical data

Air direction	Ventilation and air extraction
Installation	outside
Installation site	Wall / Channel
Material	Sheet steel, galvanised
Weight	8,48 kg
Weight including packaging	8,99 kg
Channel dimension	600 mm x 350 mm
Width	629 mm
Height	425 mm
Depth	73 mm
Width with packaging	690 mm
Height with packaging	440 mm
Depth with packaging	90 mm
Packing unit	1 piece
Range	D
GTIN (EAN)	4012799512585

LZP 31

Characteristic curve Pressure losses

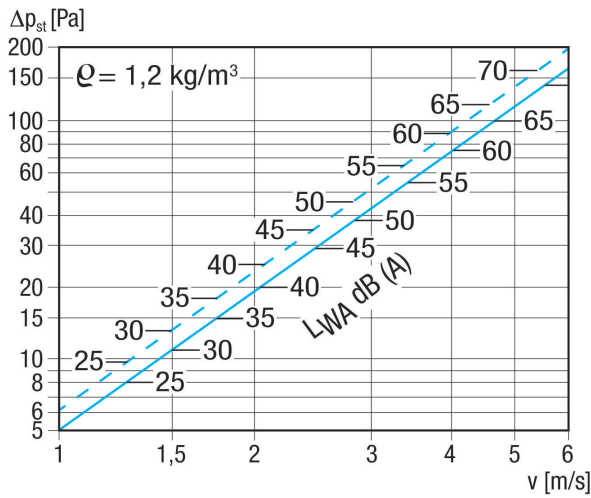

Dashed line: Pressure loss, drawing in
 Solid line: Pressure loss, pushing

Dimensioned drawing [mm]

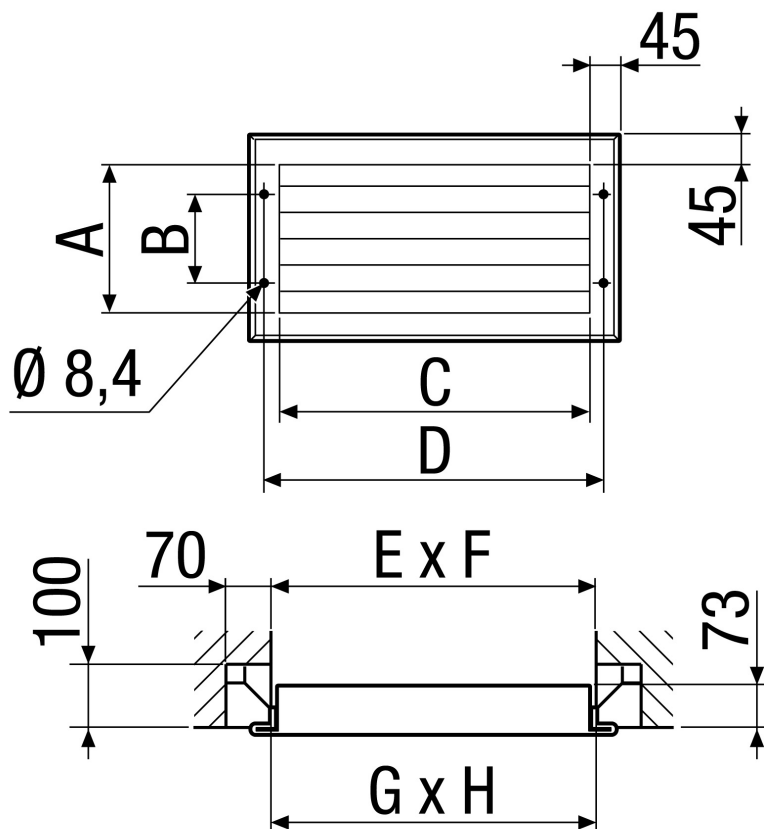

A	B	C	D	E	F	G	H
335	225	585	629	610	360	600	350

LZP 31

