

LZP 35



Short description

External grille, galvanised sheet steel, channel dimension 700 x 400 mm

Article number 0151.0259

Technical data

Air direction	Ventilation and air extraction
Installation	outside
Installation site	Wall / Channel
Material	Sheet steel, galvanised
Weight	10,7 kg
Weight including packaging	11,32 kg
Channel dimension	700 mm x 400 mm
Width	729 mm
Height	475 mm
Depth	73 mm
Width with packaging	800 mm
Height with packaging	480 mm
Depth with packaging	110 mm
Packing unit	1 piece
Range	D
GTIN (EAN)	4012799512592

LZP 35

Characteristic curve Pressure losses

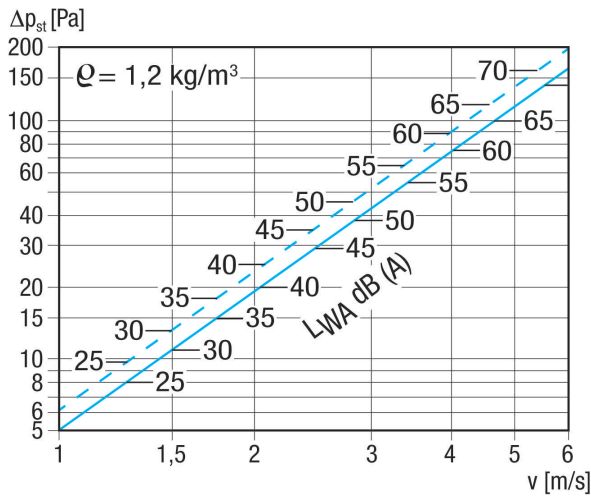

Dashed line: Pressure loss, drawing in
 Solid line: Pressure loss, pushing

Dimensioned drawing [mm]

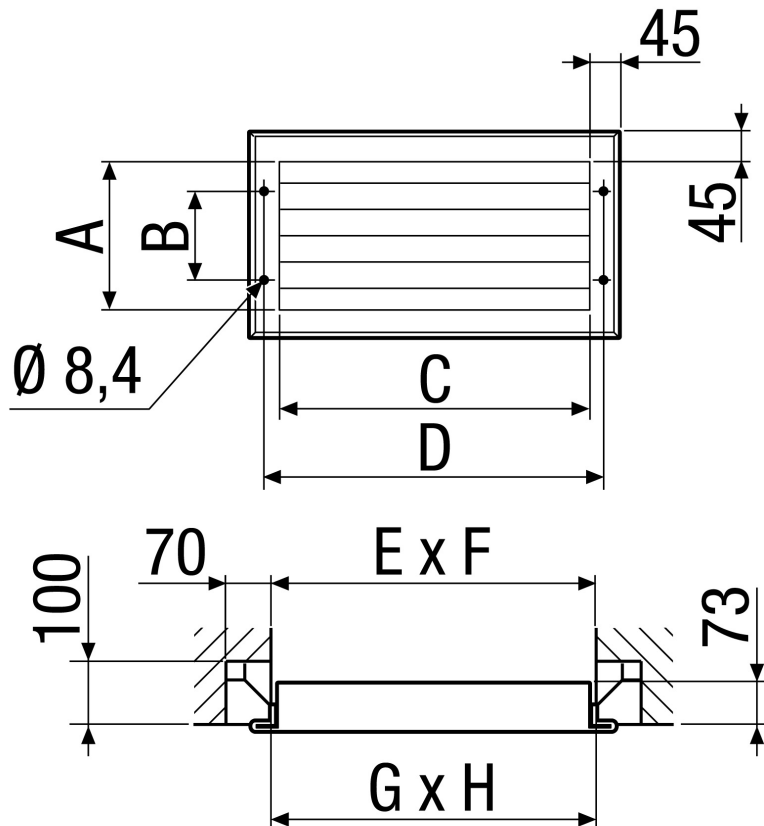

A	B	C	D	E	F	G	H
385	275	685	729	710	410	700	400

LZP 35

