

MF-V63

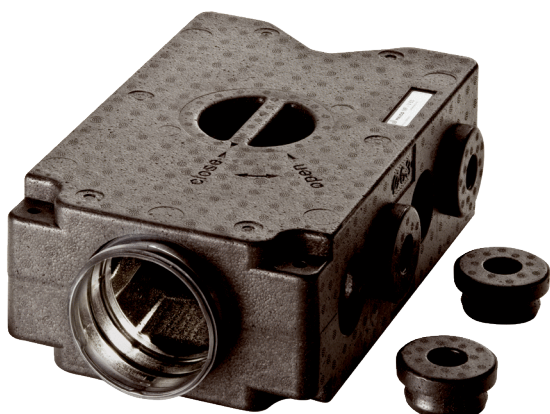

Short description

Air distributor made of sound-insulating plastic, with service opening, for 8 x MF-F63 flexible ducts, DN 125 feed duct, width x height x depth: 435 x 150 x 270 mm

Application examples

Single-family house, Multiple family unit, Industrial building, Office buildings, Modernizations

Article number 0059.0970

Technical data

Air direction	Ventilation and air extraction
Volumetric flow	160 m ³ /h (recommended)
Installation site	Ceiling / Wall / Floor
Material	Plastic EPP
Synthetic material definition	PVC-free
Weight	0,86 kg
Weight including packaging	0,9 kg
Connection diameter	125 mm
Flexible steel duct connection diameter	63 mm
Number of couplings	8
Width	435 mm
Height	150 mm
Depth	270 mm
Width with packaging	435 mm
Height with packaging	150 mm
Depth with packaging	270 mm
Packing unit	1 piece
Range	K
GTIN (EAN)	4012799599708

MF-V63

Characteristic curve

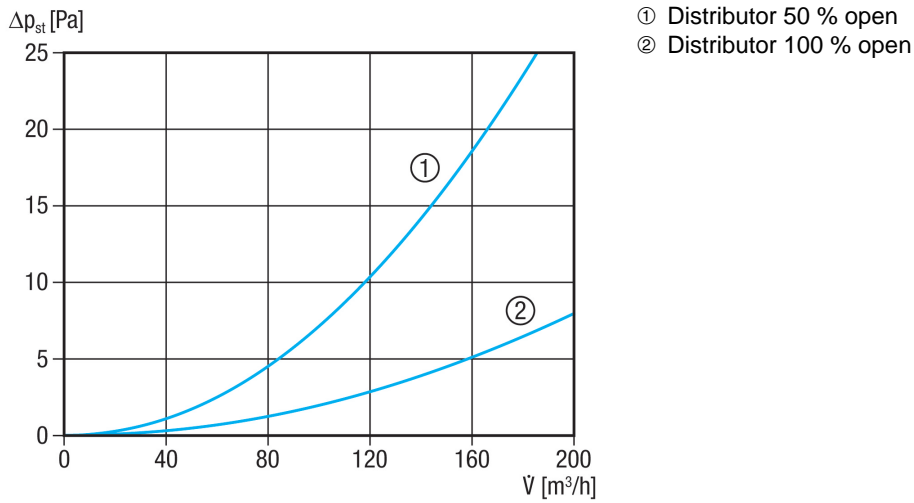

Dimensioned drawing [mm]

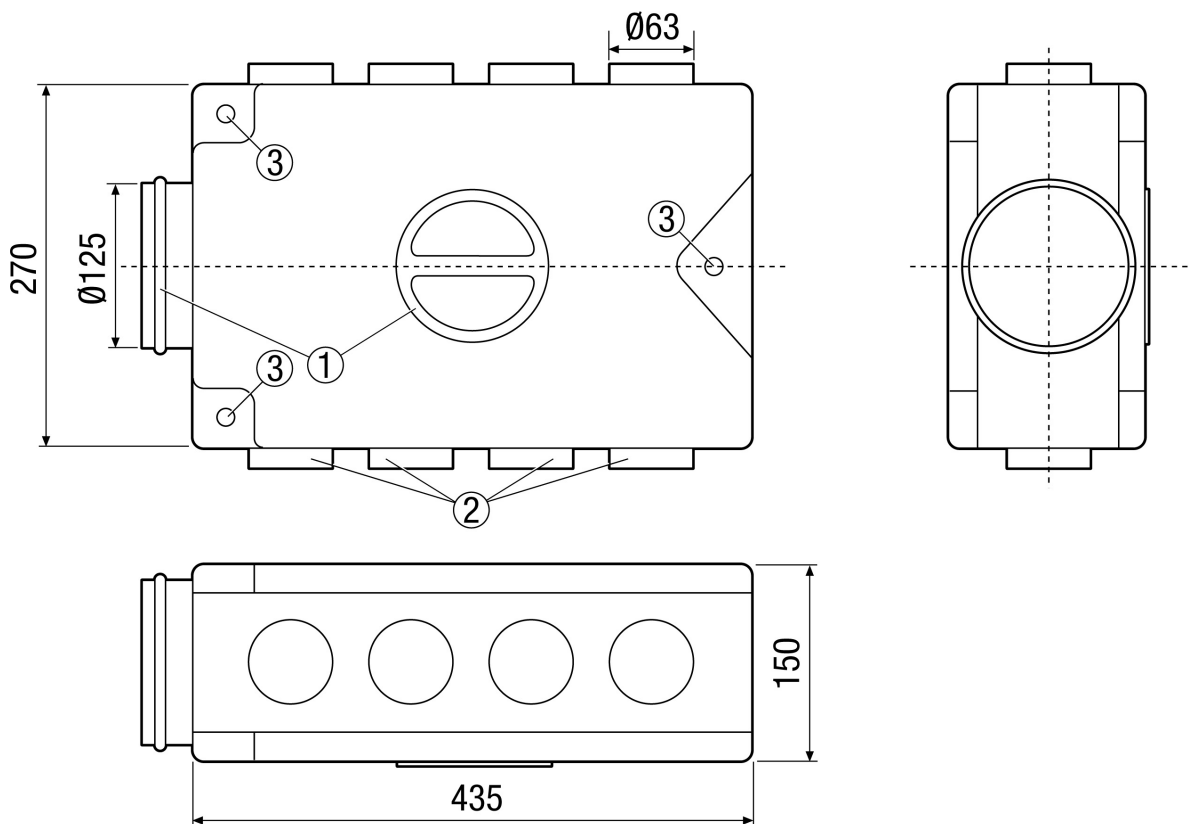

- ① Ventilation unit or service opening connection
- ② MF-F flexible steel duct connections



MF-V63

- ③ Mounting holes for threaded rods