

# REDA55/110/80



## Short description

Reducer 55/110 to 80/100, asymmetrical

Article number

0055.0706

## Technical data

Housing material	Sheet steel, Sendzimir galvanised
Weight including packaging	0 kg
Channel dimension	110 mm x x 55 mm
Reduction to channel dimension	x/ x
Width with packaging	0 mm
Height with packaging	0 mm
Depth with packaging	0 mm
Packing unit	1 piece
Range	K
GTIN (EAN)	4012799557067

## Dimensioned drawing [mm]

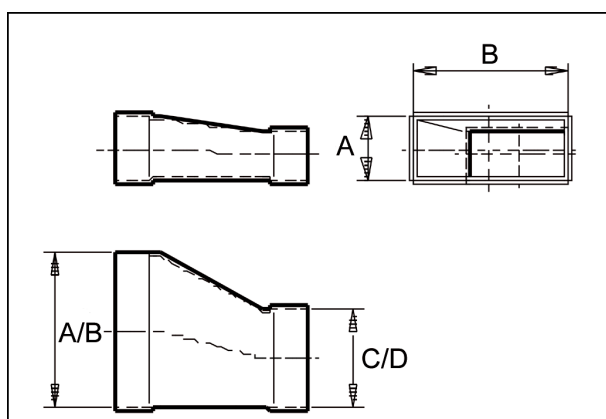

A	B	C	D
55	110	80	100