

# REDA80/150/80



## Short description

Reducer 80/150 to 80/100, asymmetrical

Article number

0055.0716

## Technical data

Housing material	Sheet steel, Sendzimir galvanised
Weight including packaging	0 kg
Channel dimension	150 mm x x 80 mm
Reduction to channel dimension	x/ x
Width with packaging	0 mm
Height with packaging	0 mm
Depth with packaging	0 mm
Packing unit	1 piece
Range	K
GTIN (EAN)	4012799557166

## Dimensioned drawing [mm]

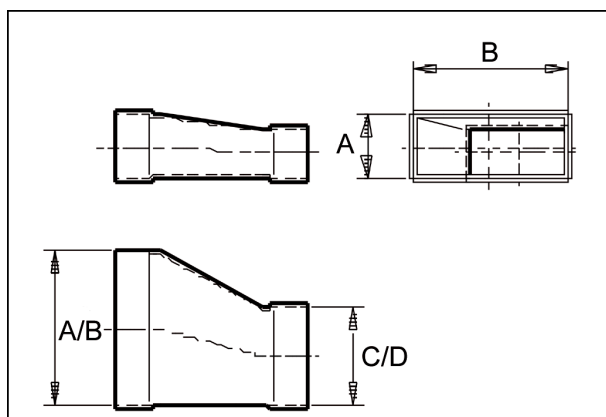

A	B	C	D
80	150	80	100