

REDA80/200/70



Short description

Reducer 80/200 to 70/170, asymmetrical

Article number

0055.0719

Technical data

Housing material	Sheet steel, Sendzimir galvanised
Weight including packaging	0 kg
Channel dimension	200 mm x x 80 mm
Reduction to channel dimension	x/ x
Width with packaging	0 mm
Height with packaging	0 mm
Depth with packaging	0 mm
Packing unit	1 piece
Range	K
GTIN (EAN)	4012799557197

Dimensioned drawing [mm]

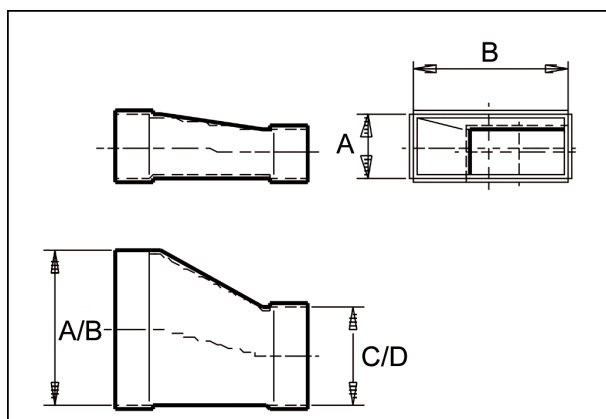

A	B	C	D
80	200	70	170