

REDS55/220/80



Short description

Reducer 55/220 to 80/100, symmetrical

Article number

0055.0694

Technical data

Material	Sheet steel, Sendzimir galvanised
Weight including packaging	0 kg
Channel dimension	220 mm x x 55 mm
Reduction to channel dimension	x/ x org.mozilla.javascript.Undefined@8ed68a
Width with packaging	0 mm
Height with packaging	0 mm
Depth with packaging	0 mm
Packing unit	1 piece
Range	K
GTIN (EAN)	4012799556947

Dimensioned drawing [mm]

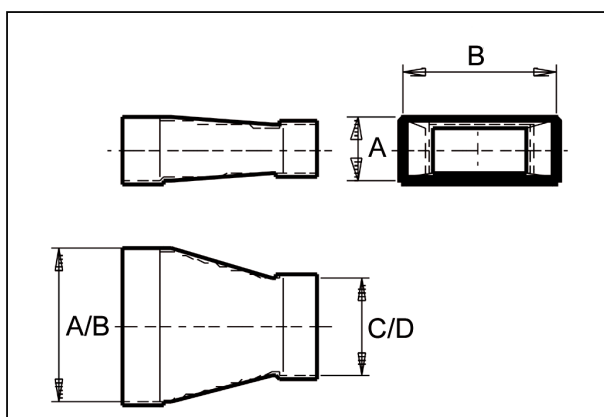

A	B	C	D
55	220	80	100