

REDS80/200/80



Short description

Reducer 80/200 to 80/150, symmetrical

Article number

0055.0702

Technical data

Material	Sheet steel, Sendzimir galvanised
Weight including packaging	0 kg
Channel dimension	200 mm x x 80 mm
Reduction to channel dimension	x/ x org.mozilla.javascript.Undefined@8ed68a
Width with packaging	0 mm
Height with packaging	0 mm
Depth with packaging	0 mm
Packing unit	1 piece
Range	K
GTIN (EAN)	4012799557029

Dimensioned drawing [mm]

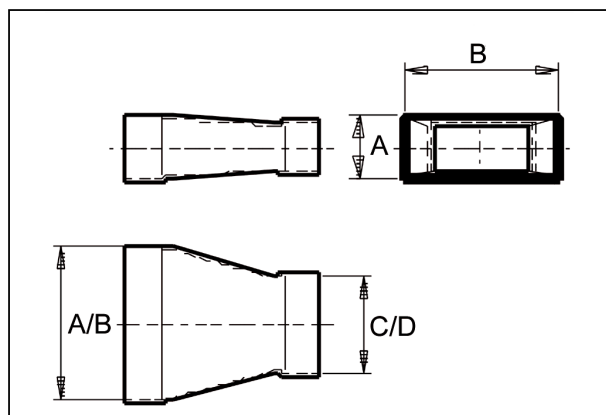

A	B	C	D
80	200	80	150