

# RSK 125



## Short description

Backflow preventer for folded spiral-seams ducts, DN 125

Article number 0092.0427

## Technical data

Type of installation	Recessed-mounted
Ambient temperature	60 °C
Packing unit	1 piece
Range	K
GTIN (EAN)	4012799924272

## Dimensioned drawing [mm]

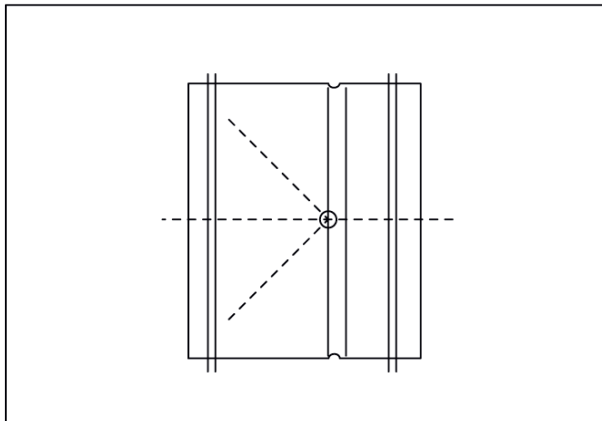

DN  
125