

RSK 160



Short description

Backflow preventer for folded spiral-seams ducts, DN 160

Article number 0092.0429

Technical data

Type of installation	Recessed-mounted
Ambient temperature	60 °C
Packing unit	1 piece
Range	K
GTIN (EAN)	4012799924296

Dimensioned drawing [mm]

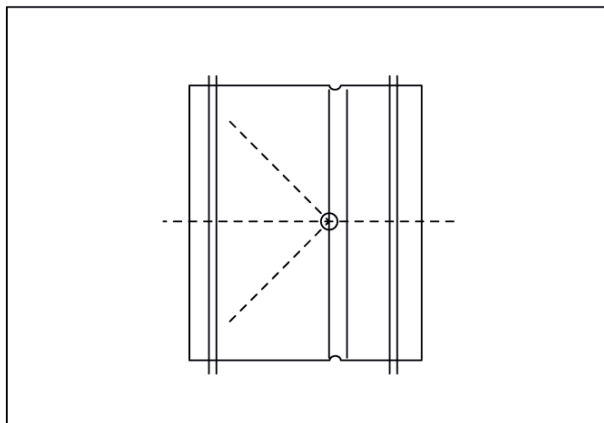

DN
160