

RSK 200



Short description

Backflow preventer for folded spiral-seams ducts, DN 200

Article number 0092.0431

Technical data

Type of installation	Recessed-mounted
Ambient temperature	60 °C
Packing unit	1 piece
Range	K
GTIN (EAN)	4012799924319

Dimensioned drawing [mm]

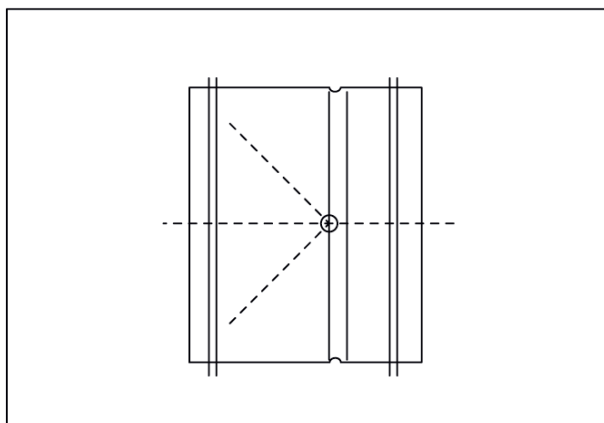

DN
200