

RS 45



Short description

Shutter, manual operation, DN 450

Article number 0151.0343

Technical data

Air direction	Ventilation and air extraction
Installation	outside
Installation site	Wall
Installation position	vertical
Material	Synthetic material, weather and UV resistant
Colour	Traffic white, similar to RAL 9016
Lamella colour	Silver grey
Weight	2,25 kg
Weight including packaging	2,63 kg
Type of shutter	electrical / manual
Nominal size	450 mm
Width	526 mm
Height	526 mm
Depth	41 mm
Width with packaging	590 mm
Height with packaging	540 mm
Depth with packaging	50 mm
Ambient temperature	60 °C
Packing unit	1 piece
Range	C
GTIN (EAN)	4012799513438

RS 45

Characteristic curve Pressure losses

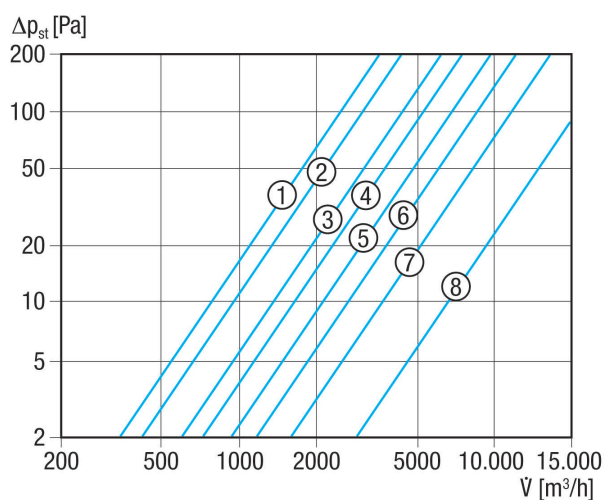

- ① RS 20
- ② RS 25
- ③ RS 30
- ④ RS 35
- ⑤ RS 40
- ⑥ RS 45
- ⑦ RS 50
- ⑧ RS 60

Dimensioned drawing [mm]

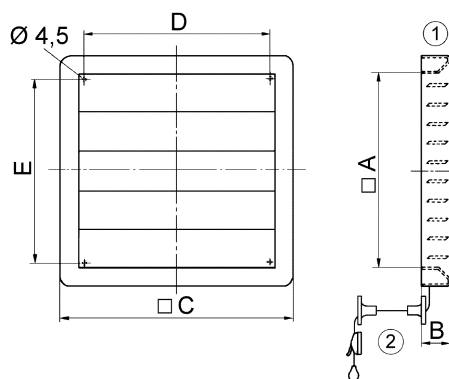

A	B	C	D	E
465	41	526	460	442

- ① Manually adjustable
- ② Pulley for pull cord