

SD 35



Short description

Socket sound absorbers for suction side sound insulation of roof fans, DN 355 mm

Article number 0092.0341

Technical data

Min. flow velocity	
Max. flow velocity	20 m/s
Housing material	Sheet steel, galvanised
Weight	34,7 kg
Weight including packaging	36 kg
Suitable for nominal size	355 mm
Width	955 mm
Height	850 mm
Depth	955 mm
Width with packaging	975 mm
Height with packaging	880 mm
Depth with packaging	975 mm
Insertion loss at 63 Hz	
Insertion loss at 125 Hz	2 dB
Insertion loss at 250 Hz	4 dB
Insertion loss at 500 Hz	18 dB
Insertion loss at 1 kHz	18 dB
Insertion loss at 2 kHz	22 dB
Insertion loss at 4 kHz	20 dB
Insertion loss at 8 kHz	
Total insertion loss	9 dB
Insertion loss note	
Packing unit	1 piece
Range	C
GTIN (EAN)	4012799923411

SD 35

Dimensioned drawing [mm]

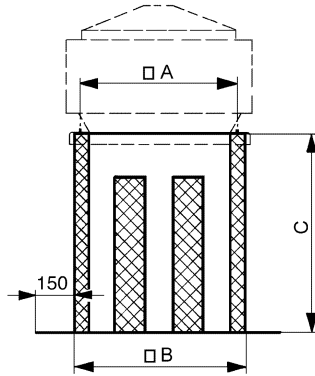

A	B	C
610	655	850