

SD 40



Short description

Socket sound absorbers for suction side sound insulation of roof fans, DN 400 mm

Article number 0092.0342

Technical data

Min. flow velocity	
Max. flow velocity	20 m/s
Housing material	Sheet steel, galvanised
Weight	39 kg
Weight including packaging	39 kg
Suitable for nominal size	400 mm
Width	995 mm
Height	850 mm
Depth	995 mm
Width with packaging	995 mm
Height with packaging	850 mm
Depth with packaging	995 mm
Insertion loss at 63 Hz	
Insertion loss at 125 Hz	1 dB
Insertion loss at 250 Hz	9 dB
Insertion loss at 500 Hz	21 dB
Insertion loss at 1 kHz	19 dB
Insertion loss at 2 kHz	19 dB
Insertion loss at 4 kHz	16 dB
Insertion loss at 8 kHz	
Total insertion loss	11 dB
Insertion loss note	
Packing unit	1 piece
Range	C
GTIN (EAN)	4012799923428

SD 40

Dimensioned drawing [mm]

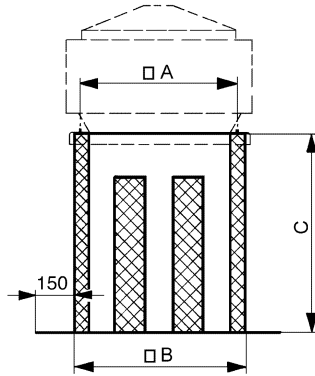

A	B	C
650	695	850