

SGR 12

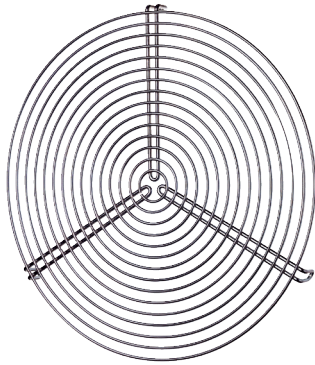

Short description

Protective grille for ventilation and air extraction, metal, DN 125

Article number 0150.0124

Technical data

Air direction	Ventilation and air extraction
Material	Wire, chromated
Weight	0,09 kg
Weight including packaging	0,09 kg
Suitable for nominal size	125 mm
Width	120 mm
Height	120 mm
Depth	120 mm
Width with packaging	120 mm
Height with packaging	120 mm
Depth with packaging	120 mm
Packing unit	1 piece
Range	C
GTIN (EAN)	4012799501244

SGR 12

Dimensioned drawing [mm]

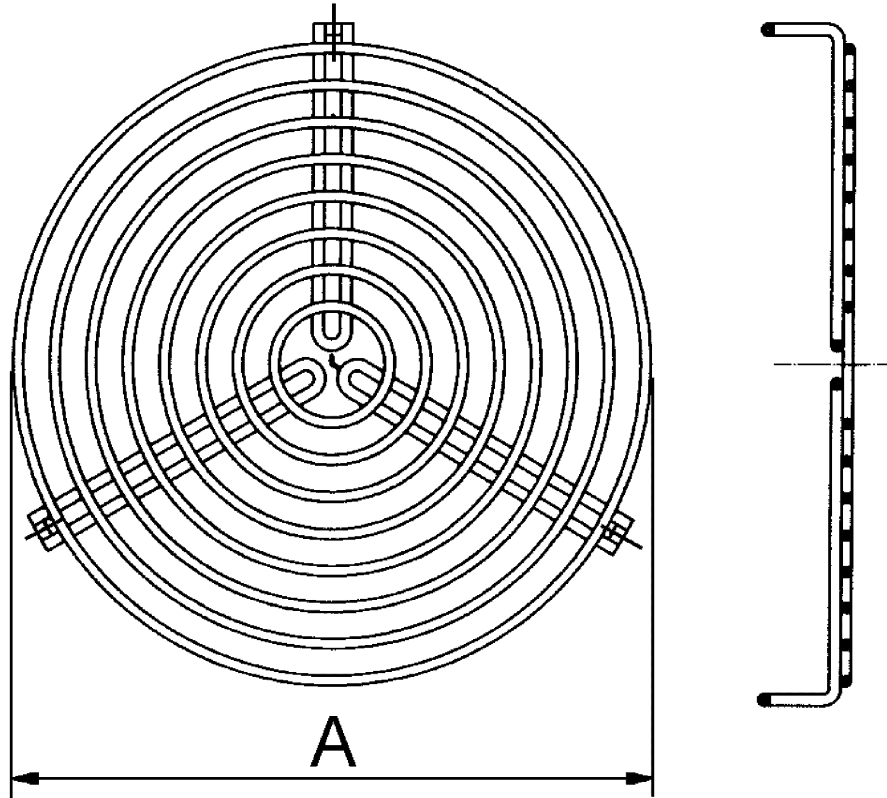

A
125