

SGR 16

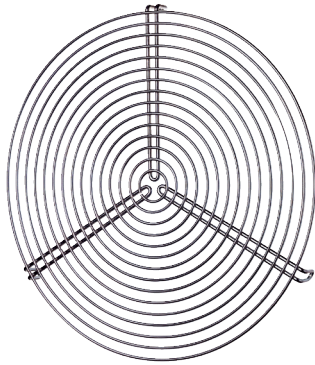

Short description

Protective grille for ventilation and air extraction, metal, DN 160

Article number 0150.0125

Technical data

Air direction	Ventilation and air extraction
Material	Wire, chromated
Weight	0,1 kg
Weight including packaging	0,1 kg
Suitable for nominal size	160 mm
Width	160 mm
Height	160 mm
Depth	160 mm
Width with packaging	161 mm
Height with packaging	161 mm
Depth with packaging	161 mm
Packing unit	1 piece
Range	C
GTIN (EAN)	4012799501251

SGR 16

Dimensioned drawing [mm]

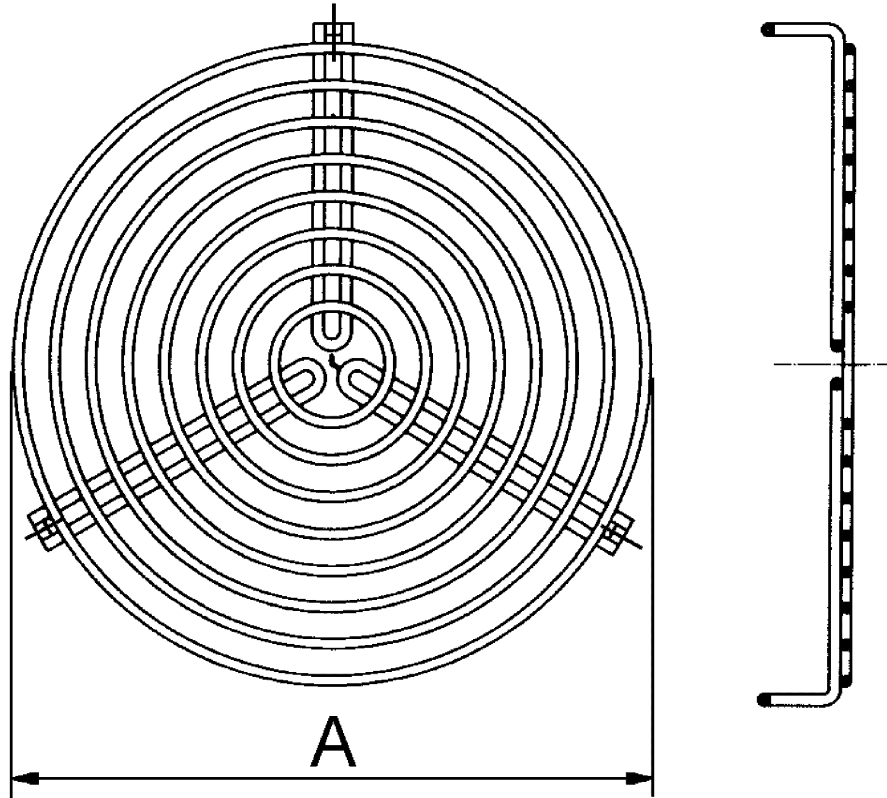

A
160