

SGR 20

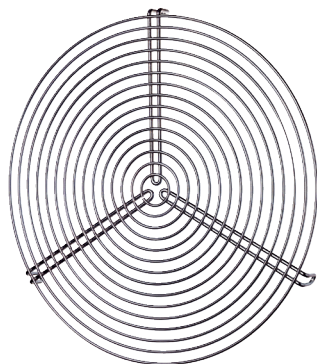

Short description

Protective grille for ventilation and air extraction, metal, DN 200

Article number 0150.0126

Technical data

Air direction	Ventilation and air extraction
Material	Wire, chromated
Weight	0,2 kg
Weight including packaging	0,2 kg
Suitable for nominal size	200 mm
Width	200 mm
Height	200 mm
Depth	200 mm
Width with packaging	200 mm
Height with packaging	200 mm
Depth with packaging	200 mm
Packing unit	1 piece
Range	C
GTIN (EAN)	4012799501268

SGR 20

Dimensioned drawing [mm]

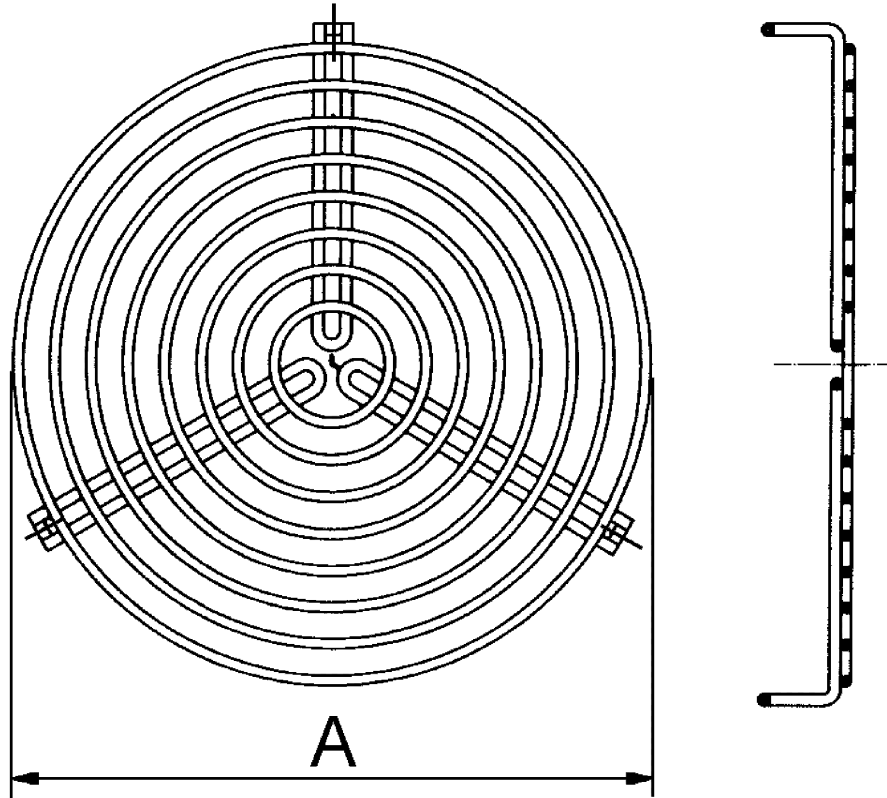

A
200