

# SGR 25

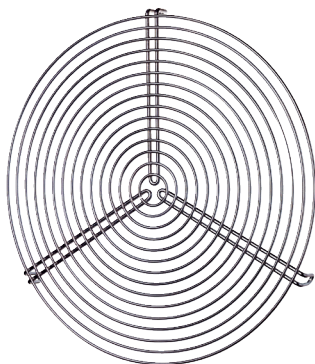

## Short description

Protective grille for ventilation and air extraction, metal, DN 250

Article number 0150.0127

## Technical data

Air direction	Ventilation and air extraction
Material	Wire, chromated
Weight	0,3 kg
Weight including packaging	0,3 kg
Suitable for nominal size	250 mm
Width	250 mm
Height	250 mm
Depth	255 mm
Width with packaging	250 mm
Height with packaging	250 mm
Depth with packaging	255 mm
Packing unit	1 piece
Range	C
GTIN (EAN)	4012799501275

# SGR 25

Dimensioned drawing [mm]

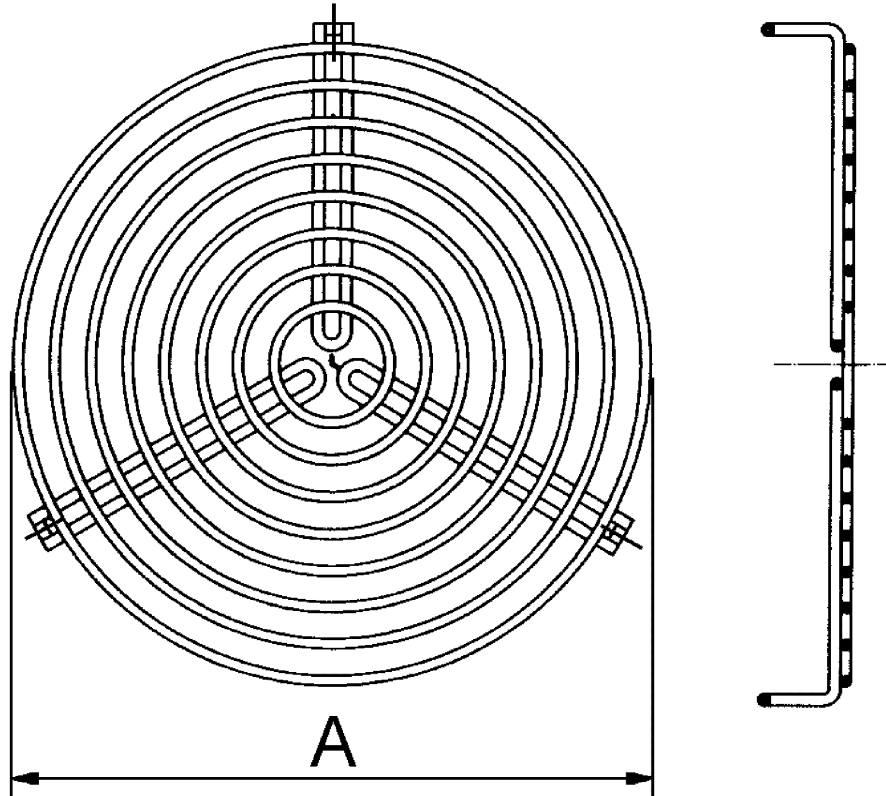

A  
250