

# SOK 22



## Short description

Flat roof socket for assembly of roof fans, with tilting device to move the fan out of the way when working on the ventilation duct, DN 225 mm

Article number 0093.0991

## Technical data

Housing material	Sheet steel, galvanised
Weight	13,5 kg
Weight including packaging	13,53 kg
Swivellable	✓
Suitable for nominal size	225 mm
Width	805 mm
Height	290 mm
Depth	805 mm
Width with packaging	805 mm
Height with packaging	290 mm
Depth with packaging	805 mm
Packing unit	1 piece
Range	C
GTIN (EAN)	4012799939917

## Dimensioned drawing [mm]

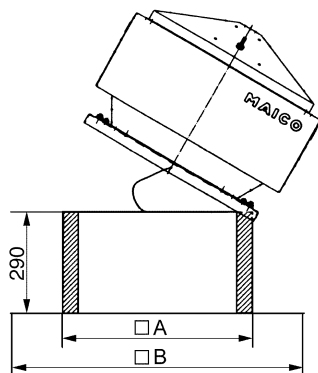

A	B
505	805