

SOK 31



Short description

Flat roof socket for assembly of roof fans, with tilting device to move the fan out of the way when working on the ventilation duct, DN 315 mm

Article number 0093.0993

Technical data

Housing material	Sheet steel, galvanised
Weight	15,2 kg
Weight including packaging	15,21 kg
Swivellable	✓
Suitable for nominal size	315 mm
Width	915 mm
Height	290 mm
Depth	915 mm
Width with packaging	915 mm
Height with packaging	290 mm
Depth with packaging	915 mm
Packing unit	1 piece
Range	C
GTIN (EAN)	4012799939931

Dimensioned drawing [mm]

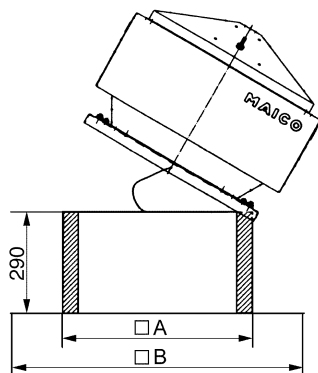

A	B
615	915