

SOK 35



Short description

Flat roof socket for assembly of roof fans, with tilting device to move the fan out of the way when working on the ventilation duct, DN 355 mm

Article number 0093.0994

Technical data

Housing material	Sheet steel, galvanised
Weight	15,5 kg
Weight including packaging	16,89 kg
Swivellable	✓
Suitable for nominal size	355 mm
Width	955 mm
Height	290 mm
Depth	955 mm
Width with packaging	955 mm
Height with packaging	290 mm
Depth with packaging	955 mm
Packing unit	1 piece
Range	C
GTIN (EAN)	4012799939948

Dimensioned drawing [mm]

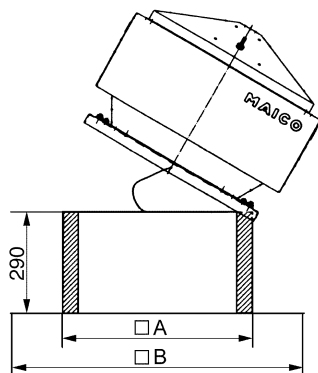

A	B
655	955