

SO 30

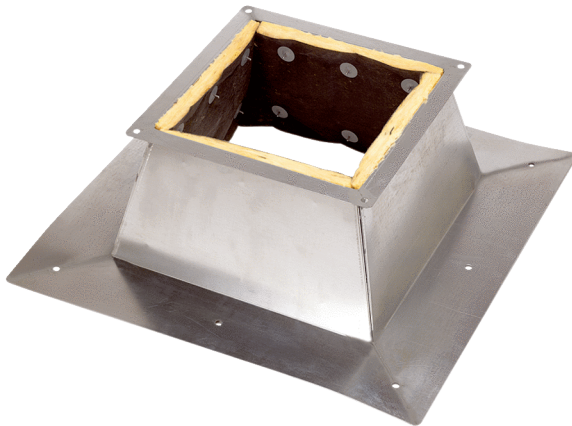

Short description

Flat roof socket for assembly of roof fans, DN 300 mm

Article number 0093.0361

Technical data

Housing material	Sheet steel, galvanised
Weight	10,7 kg
Weight including packaging	15,5 kg
Suitable for nominal size	300 mm
Width	970 mm
Height	290 mm
Depth	970 mm
Width with packaging	980 mm
Height with packaging	310 mm
Depth with packaging	980 mm
Packing unit	1 piece
Range	C
GTIN (EAN)	4012799933618

Dimensioned drawing [mm]

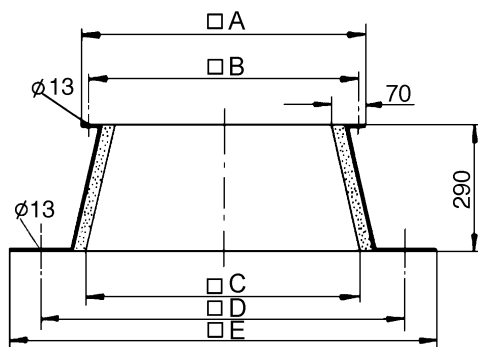

A	B	C	D	E
610	570	610	820	970