

SR 100-160



Short description

90° welding saddles with O-ring gasket for folded spiral-seams ducts, DN 100 / 140-160

Article number 0055.0443

Technical data

Type of installation	Recessed-mounted
Ambient temperature	60 °C
Packing unit	1 piece
Range	K
GTIN (EAN)	4012799554431

Dimensioned drawing [mm]

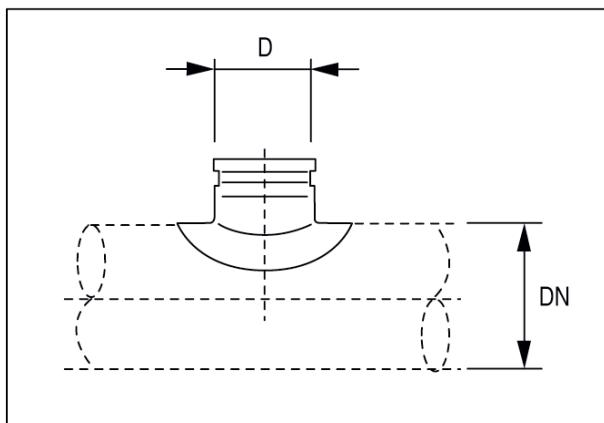

DN	D
-20	100