

# SR 180-224



## Short description

90° welding saddles with O-ring gasket for folded spiral-seams ducts, DN 180 / 200-224

Article number 0055.0453

## Technical data

Type of installation	Recessed-mounted
Ambient temperature	60 °C
Packing unit	1 piece
Range	K
GTIN (EAN)	4012799554530

## Dimensioned drawing [mm]

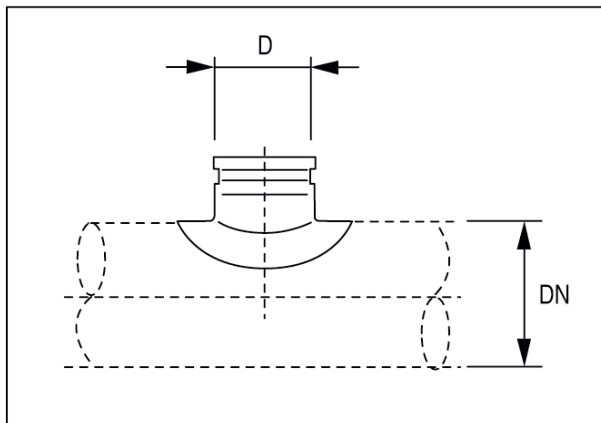

DN	D
-24	180