

# SR 80-160



## Short description

90° welding saddles with O-ring gasket for folded spiral-seams ducts, DN 80 / 140-160

Article number 0055.0439

## Technical data

Type of installation	Recessed-mounted
Ambient temperature	60 °C
Packing unit	1 piece
Range	K
GTIN (EAN)	4012799554394

## Dimensioned drawing [mm]

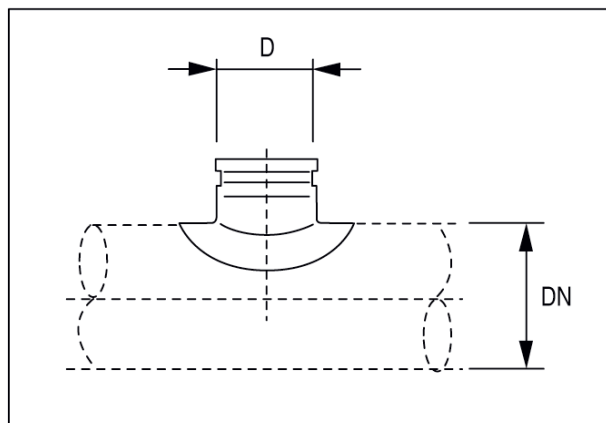

DN	D
-20	80