

SVF 180

Short description

Plug connector for adaptor, DN 180



Article number 0055.0054

Technical data

Type of installation	Recessed-mounted
Material	Sheet steel
Nominal size	180 mm
Ambient temperature	60 °C
Packing unit	1 piece
Range	K
GTIN (EAN)	4012799550549

Dimensioned drawing [mm]

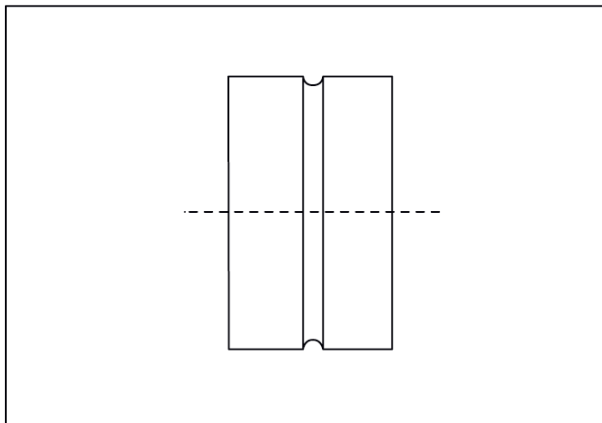

DN

180