

TFE 15-4

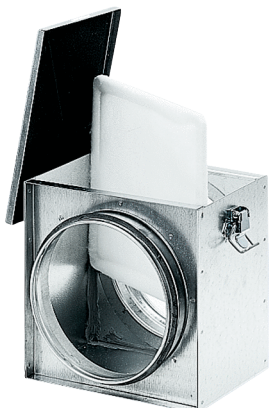

Short description

Air filter for duct installation, DN 150

Article number 0149.0076

Technical data

Installation position	vertical / horizontal
Housing material	Sheet steel, galvanised
Weight	2,6 kg
Weight including packaging	2,86 kg
Filter class	ISO Coarse 70 % (G4)
Nominal size	150 mm
Width	260 mm
Height	230 mm
Depth	205 mm
Width with packaging	290 mm
Height with packaging	290 mm
Depth with packaging	260 mm
Ambient temperature	100 °C
Packing unit	1 piece
Range	C
GTIN (EAN)	4012799490760

TFE 15-4

Characteristic curve Pressure losses

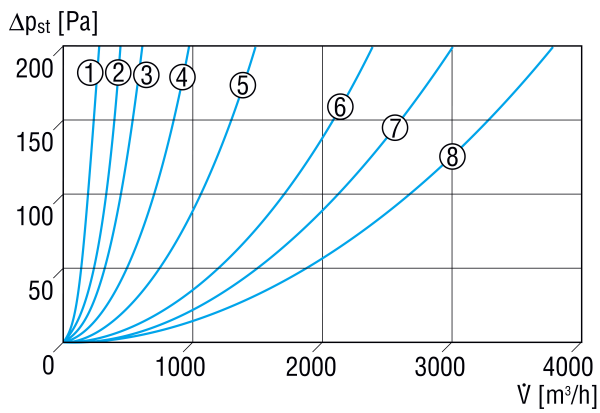

- ① TFE 10-4
- ② TFE 12-4
- ③ TFE 15-4, TFE 16-4
- ④ TFE 20-4
- ⑤ TFE 25-4
- ⑥ TFE 31-4
- ⑦ TFE 35-4
- ⑧ TFE 40-4

Dimensioned drawing [mm]

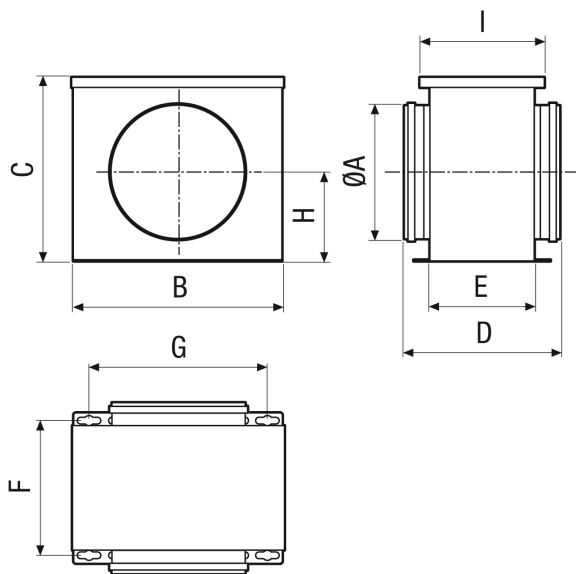

A	B	C	D	E	F	G	H	I
150	261	229	205	129	152	211	114,5	160