

# TFE 20-7



## Short description

Air filter for duct installation, DN 200

Article number 0149.0053

## Technical data

Installation position	vertical / horizontal
Housing material	Sheet steel, galvanised
Weight	4,04 kg
Weight including packaging	4,55 kg
Type of filter	Dust and pollen filter
Filter class	ISO ePM1 50 % (F7)
Nominal size	200 mm
Width	360 mm
Height	330 mm
Depth	300 mm
Width with packaging	405 mm
Height with packaging	405 mm
Depth with packaging	410 mm
Ambient temperature	80 °C
Packing unit	1 piece
Range	C
GTIN (EAN)	4012799490531

# TFE 20-7

## Characteristic curve Pressure losses

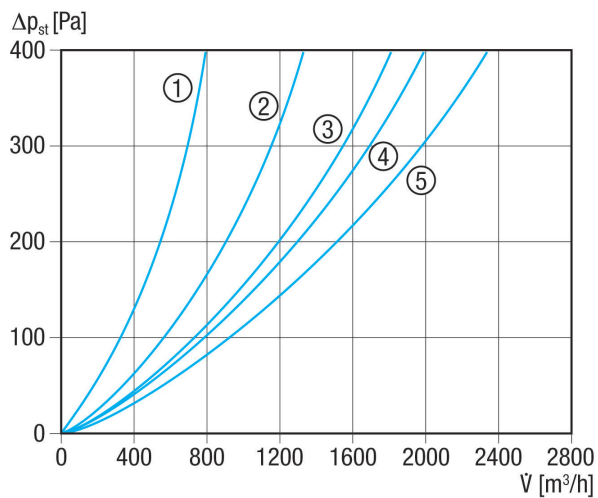

- ① TFE 10-7 to TFE 16-7
- ② TFE 20-7
- ③ TFE 25-7
- ④ TFE 31-7 and TFE 35-7
- ⑤ TFE 40-7

## Dimensioned drawing [mm]

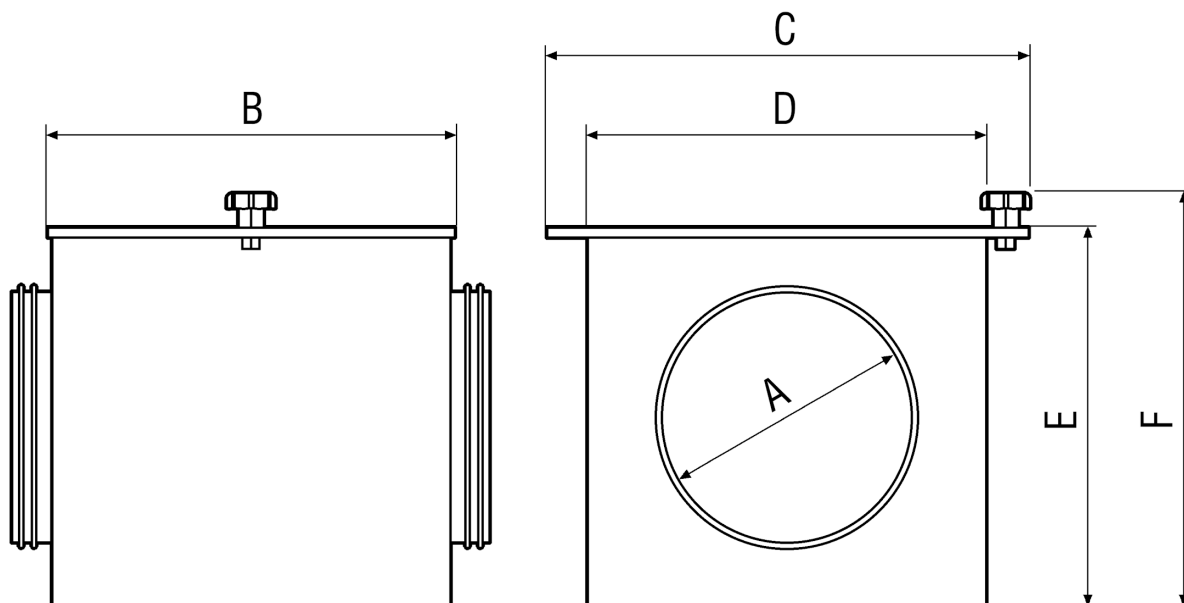



# TFE 20-7

A	B	C	D	E	F
200	300	360	300	300	330