

TFE 25-4

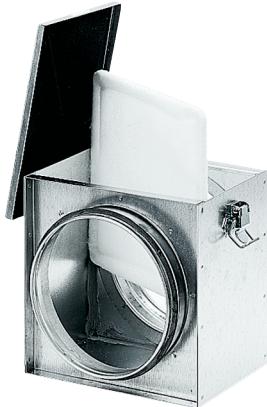

Short description

Air filter for duct installation, DN 250, ISO Coarse 70 % (G4)

Article number 0149.0079

Technical data

Installation position	vertical / horizontal
Housing material	Sheet steel, galvanised
Weight	5,05 kg
Weight including packaging	5,63 kg
Filter class	ISO Coarse 70 % (G4)
Nominal size	250 mm
Width	365 mm
Height	325 mm
Depth	325 mm
Width with packaging	400 mm
Height with packaging	380 mm
Depth with packaging	350 mm
Ambient temperature	100 °C
Packing unit	1 piece
Range	C
GTIN (EAN)	4012799490791

TFE 25-4

Characteristic curve Pressure losses

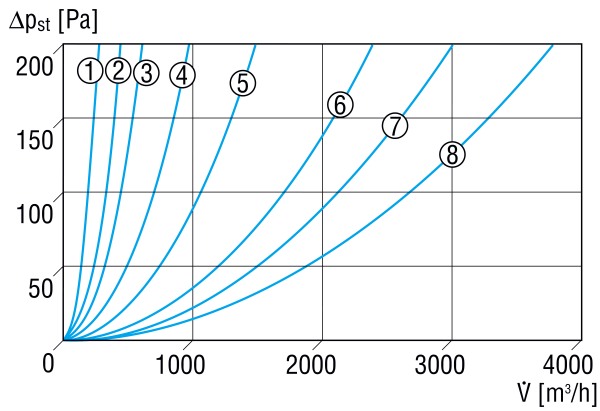

- ① TFE 10-4
- ② TFE 12-4
- ③ TFE 15-4, TFE 16-4
- ④ TFE 20-4
- ⑤ TFE 25-4
- ⑥ TFE 31-4
- ⑦ TFE 35-4
- ⑧ TFE 40-4

Dimensioned drawing [mm]

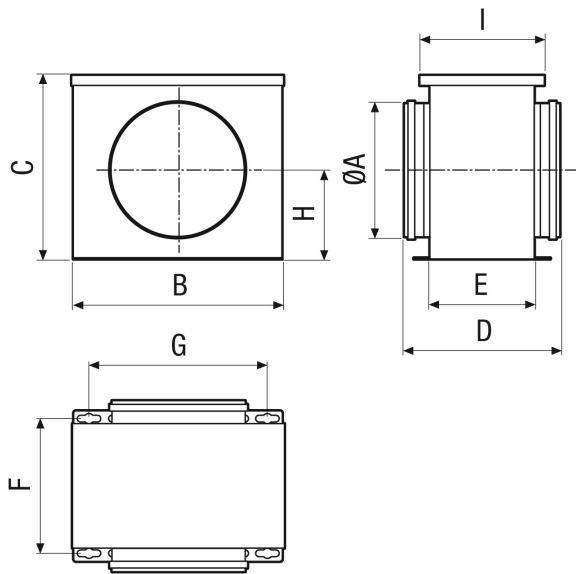

A	B	C	D	E	F	G	H	I
250	357	318	320	204	227	307	159	235