

# TFE 31-5



## Short description

Air filter for duct installation, DN 315

Article number 0149.0064

## Technical data

Installation position	vertical / horizontal
Housing material	Sheet steel, galvanised
Weight	7,655 kg
Weight including packaging	9 kg
Filter class	F5
Nominal size	315 mm
Width	460 mm
Height	530 mm
Depth	300 mm
Width with packaging	480 mm
Height with packaging	660 mm
Depth with packaging	480 mm
Ambient temperature	80 °C
Packing unit	1 piece
Range	C
GTIN (EAN)	4012799490647

# TFE 31-5

## Characteristic curve Pressure losses



- ① TFE 10-5 to TFE 16-5
- ② TFE 20-5
- ③ TFE 25-5
- ④ TFE 31-5 and TFE 35-5
- ⑤ TFE 40-5

## Dimensioned drawing [mm]

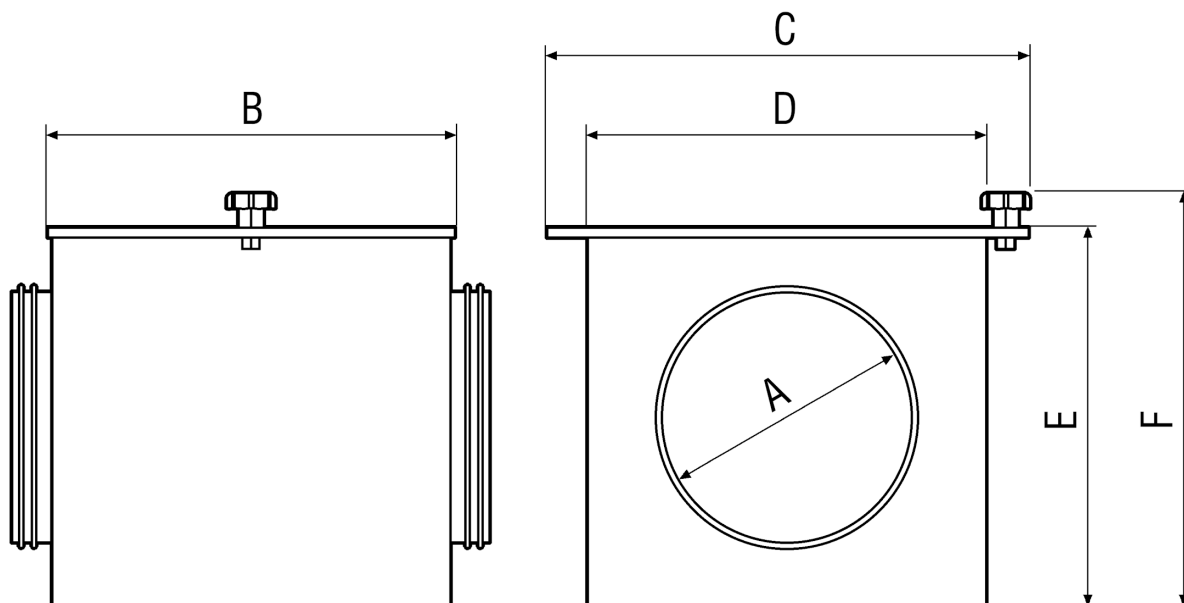



# TFE 31-5

A	B	C	D	E	F
315	300	460	400	500	530