

TFE 35-7



Short description

Air filter for duct installation, DN 355

Article number 0149.0056

Technical data

Installation position	vertical / horizontal
Housing material	Sheet steel, galvanised
Weight	7,5 kg
Weight including packaging	8,85 kg
Type of filter	Dust and pollen filter
Filter class	ISO ePM1 50 % (F7)
Nominal size	355 mm
Width	460 mm
Height	530 mm
Depth	300 mm
Width with packaging	485 mm
Height with packaging	650 mm
Depth with packaging	485 mm
Ambient temperature	80 °C
Packing unit	1 piece
Range	C
GTIN (EAN)	4012799490562

TFE 35-7

Characteristic curve Pressure losses

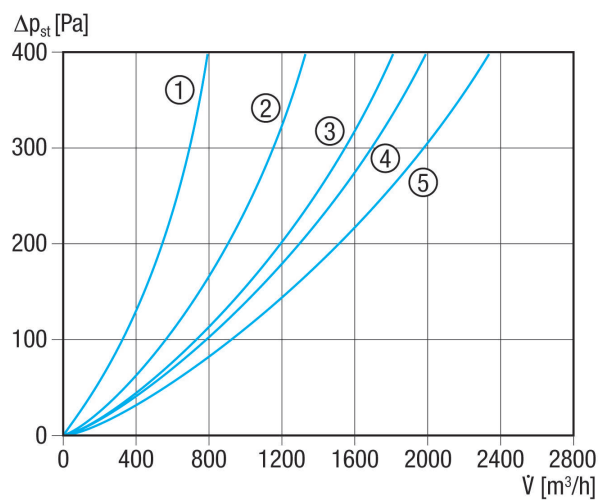

- ① TFE 10-7 to TFE 16-7
- ② TFE 20-7
- ③ TFE 25-7
- ④ TFE 31-7 and TFE 35-7
- ⑤ TFE 40-7

Dimensioned drawing [mm]

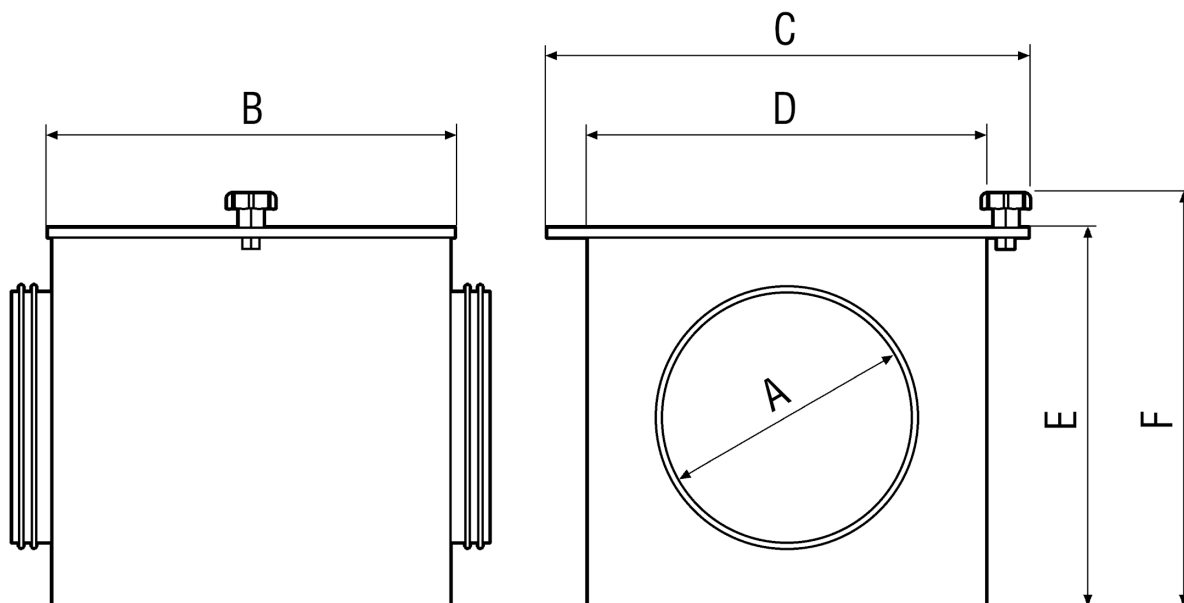



TFE 35-7

A	B	C	D	E	F
355	300	460	400	500	530