

# TFE 40-5



## Short description

Air filter for duct installation, DN 400

Article number 0149.0066

## Technical data

Installation position	vertical / horizontal
Housing material	Sheet steel, galvanised
Weight	8,73 kg
Weight including packaging	10,68 kg
Filter class	F5
Nominal size	400 mm
Width	560 mm
Height	530 mm
Depth	300 mm
Width with packaging	800 mm
Height with packaging	610 mm
Depth with packaging	410 mm
Ambient temperature	80 °C
Packing unit	1 piece
Range	C
GTIN (EAN)	4012799490661

# TFE 40-5

## Characteristic curve Pressure losses

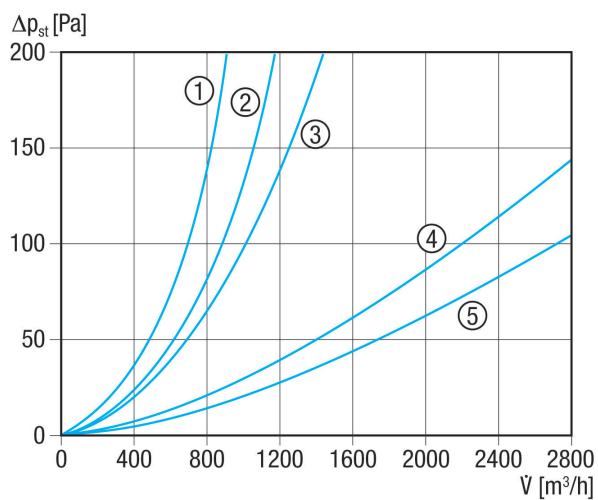

- ① TFE 10-5 to TFE 16-5
- ② TFE 20-5
- ③ TFE 25-5
- ④ TFE 31-5 and TFE 35-5
- ⑤ TFE 40-5

## Dimensioned drawing [mm]

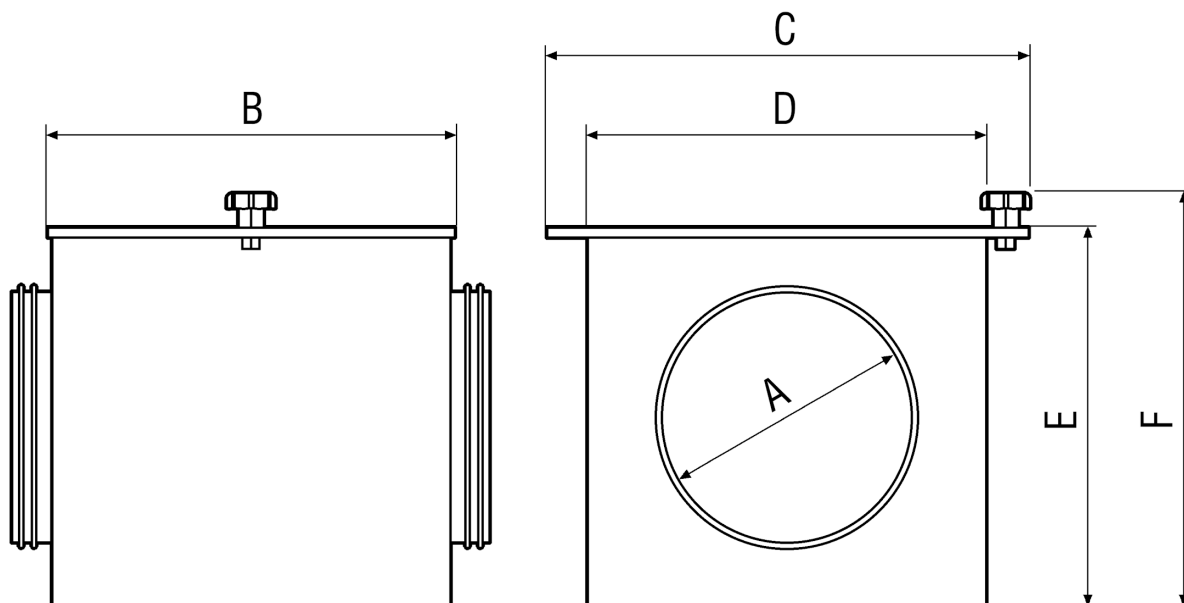



# TFE 40-5

A	B	C	D	E	F
400	300	560	500	500	530