

TFE 40-7



Short description

Air filter for duct installation, DN 400

Article number 0149.0057

Technical data

Installation position	vertical / horizontal
Housing material	Sheet steel, galvanised
Weight	8,64 kg
Weight including packaging	9,66 kg
Type of filter	Dust and pollen filter
Filter class	ISO ePM1 50 % (F7)
Nominal size	400 mm
Width	560 mm
Height	530 mm
Depth	300 mm
Width with packaging	800 mm
Height with packaging	610 mm
Depth with packaging	420 mm
Ambient temperature	80 °C
Packing unit	1 piece
Range	C
GTIN (EAN)	4012799490579

TFE 40-7

Characteristic curve Pressure losses

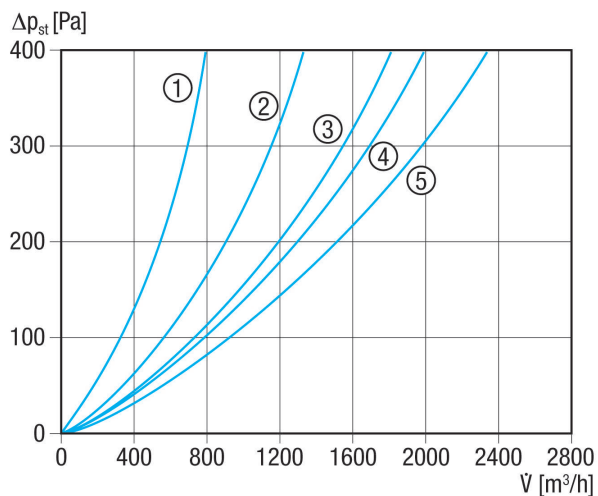

- ① TFE 10-7 to TFE 16-7
- ② TFE 20-7
- ③ TFE 25-7
- ④ TFE 31-7 and TFE 35-7
- ⑤ TFE 40-7

Dimensioned drawing [mm]

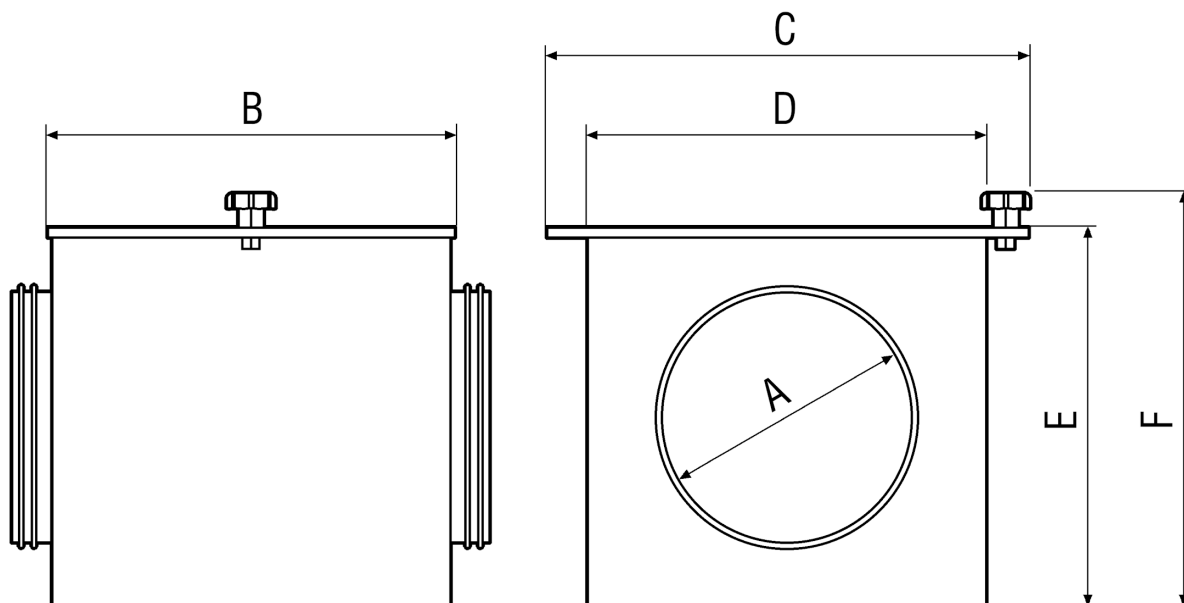



TFE 40-7

A	B	C	D	E	F
400	300	560	500	500	530