

# TFP 22



## Short description

ISO Coarse 85 % (G4) air filter for channel installation, channel dimensions 500 mm x 250 mm

Article number 0149.0031

## Technical data

Installation site	Channel
Installation position	vertical / horizontal
Housing material	Sheet steel, galvanised
Weight	8,79 kg
Weight including packaging	8,8 kg
Filter class	ISO Coarse 85 % (G4)
Channel dimension	500 mm x 250 mm
Width	540 mm
Height	290 mm
Depth	500 mm
Width with packaging	540 mm
Height with packaging	290 mm
Depth with packaging	500 mm
Airstream temperature at I <sub>Max</sub>	70 °C
Packing unit	1 piece
Range	D
GTIN (EAN)	4012799490319

# TFP 22

## Characteristic curve TFP pressure losses

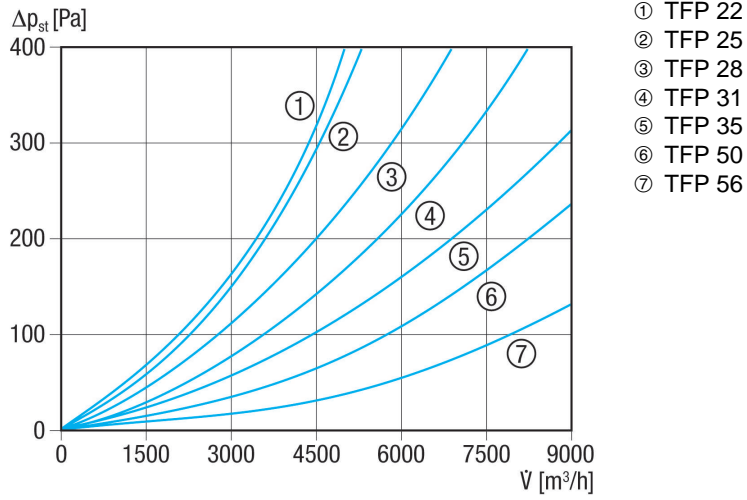

## Dimensioned drawing [mm]

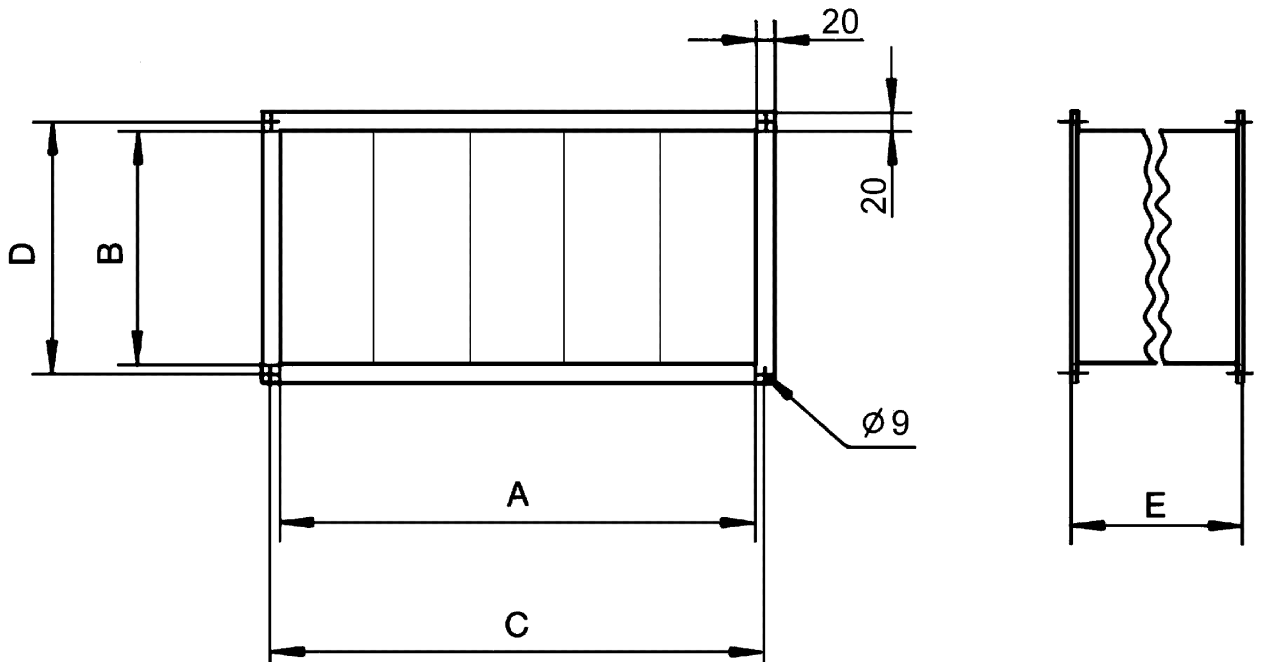

A	B	C	D	E
500	250	520	270	500

TFP 22

