

TFP 25



Short description

ISO Coarse 85 % (G4) air filter for channel installation, channel dimensions 500 mm x 300 mm

Article number 0149.0032

Technical data

Installation site	Channel
Installation position	vertical / horizontal
Housing material	Sheet steel, galvanised
Weight	9,5 kg
Weight including packaging	9,5 kg
Filter class	ISO Coarse 85 % (G4)
Channel dimension	500 mm x 300 mm
Width	540 mm
Height	340 mm
Depth	500 mm
Width with packaging	540 mm
Height with packaging	340 mm
Depth with packaging	500 mm
Airstream temperature at I _{Max}	70 °C
Packing unit	1 piece
Range	D
GTIN (EAN)	4012799490326

TFP 25

Characteristic curve TFP pressure losses

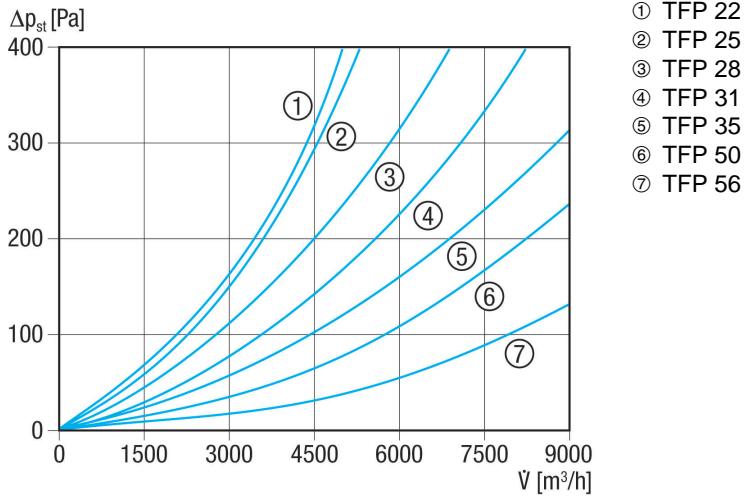

Dimensioned drawing [mm]

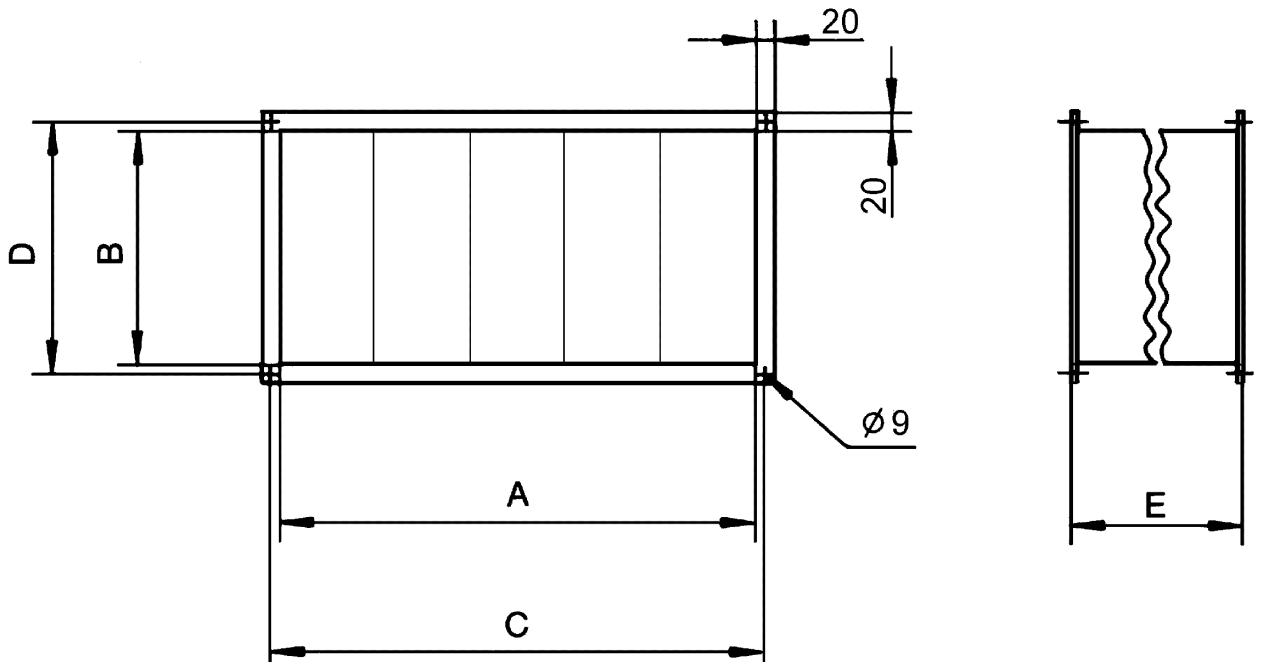

A	B	C	D	E
500	300	520	320	500



TFP 25