

URRI 12



Short description

Rectangular to round transition adapter, coated sheet steel, to DN 120

Article number 0073.0298

Technical data

Type of installation	Recessed-mounted
Material	Sheet steel, coated
Colour	grey
Weight	0,73 kg
Weight including packaging	0,73 kg
Suitable for nominal size	120 mm
Width	150 mm
Height	150 mm
Depth	140 mm
Width with packaging	150 mm
Height with packaging	150 mm
Depth with packaging	140 mm
Packing unit	1 piece
Range	C
GTIN (EAN)	4012799732983

Dimensioned drawing [mm]

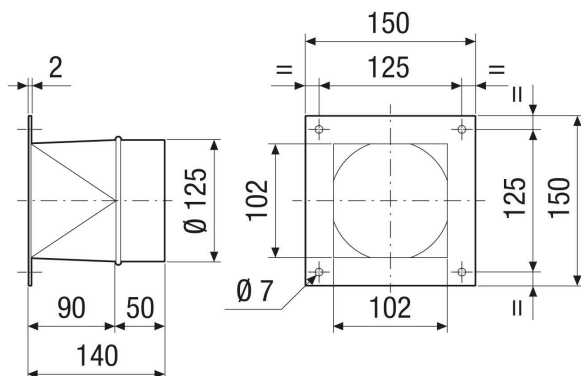

URRI 12

