

URRI 14



Short description

Rectangular to round transition adapter, coated sheet steel, to DN 140

Article number 0073.0299

Technical data

Type of installation	Recessed-mounted
Material	Sheet steel, coated
Colour	grey
Weight	0,85 kg
Weight including packaging	0,85 kg
Suitable for nominal size	140 mm
Width	175 mm
Height	175 mm
Depth	140 mm
Width with packaging	175 mm
Height with packaging	175 mm
Depth with packaging	140 mm
Packing unit	1 piece
Range	C
GTIN (EAN)	4012799732990

Dimensioned drawing [mm]

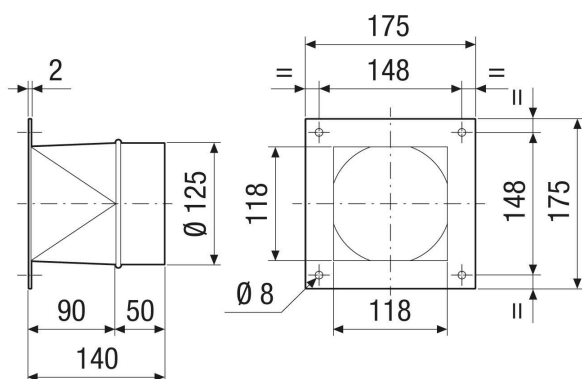

URRI 14

