

# URRI 18



## Short description

Rectangular to round transition adapter, coated sheet steel, to DN 180

Article number 0073.0301

## Technical data

Type of installation	Recessed-mounted
Material	Sheet steel, coated
Colour	grey
Weight	1,1 kg
Weight including packaging	1,1 kg
Suitable for nominal size	180 mm
Width	210 mm
Height	210 mm
Depth	140 mm
Width with packaging	210 mm
Height with packaging	210 mm
Depth with packaging	140 mm
Packing unit	1 piece
Range	C
GTIN (EAN)	4012799733010

## Dimensioned drawing [mm]

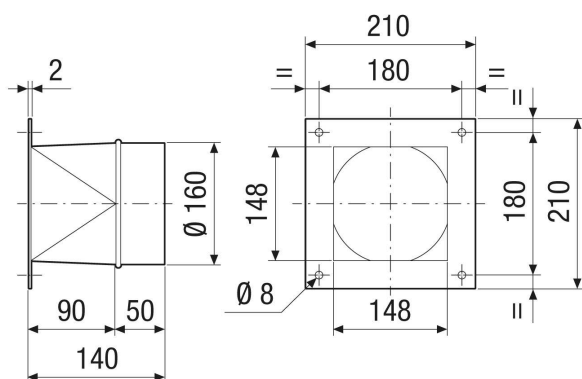

# URRI 18

