

URRI GR 12



Short description

Rectangular to round transition adapter, plastic, to DN 120

Article number 0073.0310

Technical data

Type of installation	Recessed-mounted
Material	Synthetic material
Colour	grey
Weight	0,1 kg
Weight including packaging	0,1 kg
Suitable for nominal size	120 mm
Width	135 mm
Height	135 mm
Depth	95 mm
Width with packaging	135 mm
Height with packaging	135 mm
Depth with packaging	95 mm
Packing unit	1 piece
Range	C
GTIN (EAN)	4012799733102

Dimensioned drawing [mm]

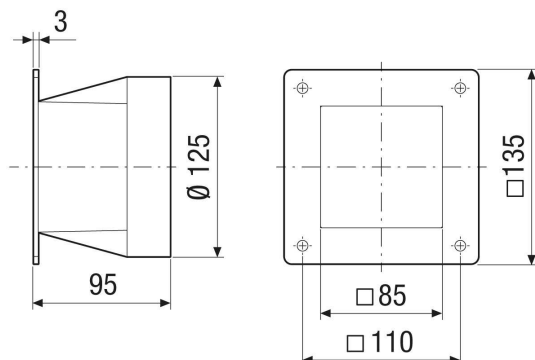

URRI GR 12

