

USAN80/150/100

Short description

Asymmetric 80/150 to D=100 mm transition piece, sheet steel, Sendzimir galvanised, suited to connection with MF-WE slide-in adaptor



Article number 0055.0668

Technical data

Type of installation	Recessed-mounted
Material	Sheet steel, Sendzimir galvanised
Weight	0,38 kg
Weight including packaging	0,38 kg
Nominal size	100 mm
Channel dimension	150 mm x x 80 mm
Width	152 mm
Height	103 mm
Depth	200 mm
Width with packaging	152 mm
Height with packaging	103 mm
Depth with packaging	200 mm
Packing unit	1 piece
Range	K
GTIN (EAN)	4012799556688

Dimensioned drawing [mm]

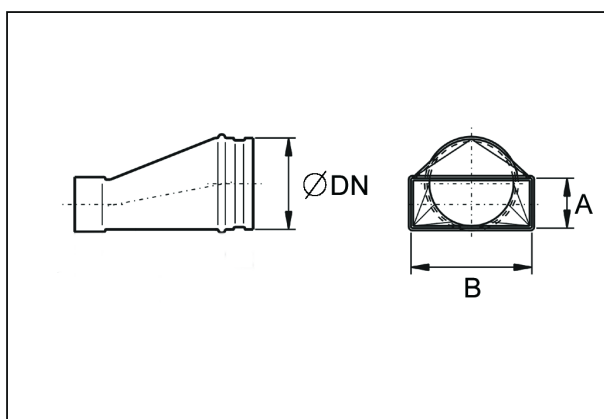

DN	A	B
100	80	150

USAN80/150/100

